

U

I

CATALOGO 2026

TRUCK
ITS / RICAMBI

U

50 anni
di esperienza

40.000 prodotti
disponibili

5.000 mt²
di magazzino

TRUCK
ITS / RICAMBI

CATALOGO 2026

01	cassette	2 7
02	porta pallet	8
03	porta transpallet	9
04	staffe	10
05	parafanghi	12 19
06	kit fissaggio parafanghi	20 23
07	kit fissaggio serbatoi	24
08	serbatoi acqua	25
09	taniche acqua	26 29
10	barra paraincastri	30 31
11	supporti paracicli	32 33
12	kit protezione laterale	34 35
13	cuneo / calzatoia	36 37
14	porta cuneo	38 39
15	profili in pvc	40
16	profili in gomma per tetto	41
17	porta documenti	42
18	porta estintore	43
19	accessori per teloni	44 48
20	tamponi paracolpi	50 51
21	paracolpi a rullo	52 53
22	barre fermacarico per interni	55
23	fermacarico	56 59
24	scaletta estraibile	60
25	basi appoggio stabilizzatori	61
26	fanale ingombro	62 75
27	fanale posteriore	76 84
28	fanale lampeggiante	85 91
29	fanale targa	92
30	fari di profondità	93 95
31	faro da lavoro	96 97
32	plafoniere da interno	98
33	nastri riflettenti	99
34	pannelli e limiti di velocità	100

Cassetta Termoplastica ad iniezione

1 MANIGLIA



L'eccellente qualità dei materiali, la struttura solida e l'affidabilità garantita dalle certificazioni ottenute rappresentano solo alcuni dei vantaggi competitivi di questa linea. Le cassette porta attrezzi Velvet sono infatti la perfetta sintesi tra alta qualità, solidità e un design unico ed elegante.

ARTICOLO	LINEA	FORMATO (mm)	CARICO kg	CAPACITÀ lt
8100002	VELVET	L410 X H300 X P300	40	29

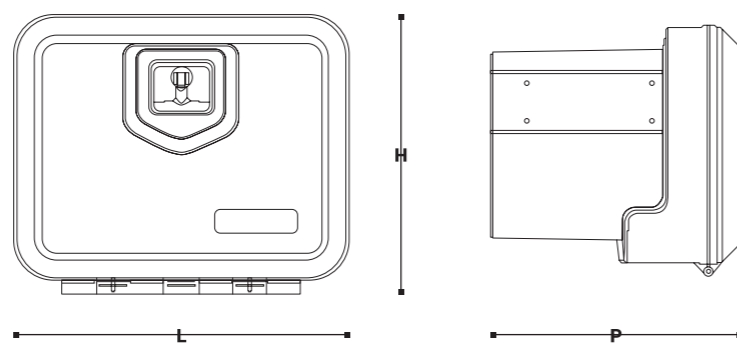

Cassetta Termoplastica ad iniezione

2 MANIGLIE



La linea di cassette porta attrezzi Just è caratterizzata dalla semplicità ed eleganza che contraddistinguono tutti i prodotti Daken. La linea Just è la soluzione efficace per le moderne esigenze di allestimento del veicolo industriale e logisticamente flessibile grazie alla possibilità di impilare il prodotto.

ARTICOLO	LINEA	FORMATO (mm)	CARICO kg	CAPACITÀ lt
81101001	JUST	L400 X H350 X P300	30	21
81102	JUST	L500 X H350 X P400	35	42
81104	JUST	L600 X H415 X P460	45	74
81106	JUST	L750 X H350 X P450	45	75
81108	JUST	L826 X H500 X P470	50	127
81109	JUST	L900 X H367 X P300	50	58
81110	JUST	L900 X H367 X P450	50	90

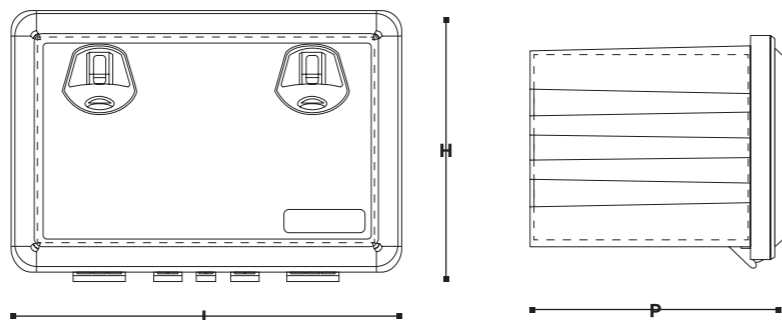

CARATTERISTICHE



Cassetta Termoplastica ad iniezione

3 MANIGLIE

Arka è la nuova linea di cassette porta attrezzi, unisce un'elevata qualità di struttura ai vantaggi dell'impilaggio del prodotto smontato. Come tutte le cassette Daken, anche la linea Arka è realizzata con la tecnica dello stampaggio ad iniezione assicurando, insieme alla struttura rinforzata, una particolare robustezza e resistenza nel tempo. Le cassette Arka sono inoltre omologate come Sistema di Protezione Laterale.

ARTICOLO	LINEA	FORMATO (mm)	CARICO kg	CAPACITÀ lt
81208	ARKA	A1062 X B522 X C500	80	169
81205	ARKA	A685 X B500 X C500	50	109

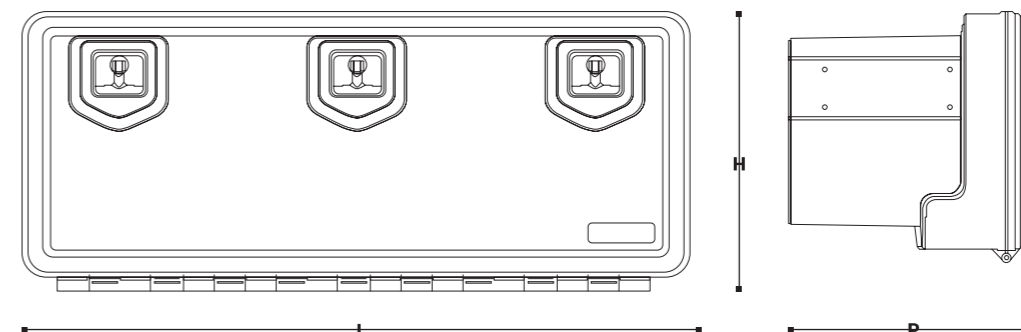

Cassetta porta attrezzi in acciaio inox opaco Z20

MANIGLIA ZEN OPACA



ARTICOLO	LINEA	FORMATO (mm)	PESO kg	CAPACITÀ lt
8Z2000	ZEN	A400 X B300 X C300	8,9	32
8Z2010	ZEN	A500 X B350 X C400	14,6	63
8Z2020	ZEN	A600 X B400 X C500	22,3	108
8Z2021	ZEN	A600 X B600 X C600	27,9	194
8Z2040	ZEN	A800 X B500 X C500	28,1	180
8Z2043	ZEN	A800 X B600 X C600	34,6	259
8Z2060	ZEN	A1000 X B500 X C500	33,4	225
8Z2063	ZEN	A1000 X B600 X C600	40,6	324
8Z2080	ZEN	A1200 X B500 X C500	38,6	270
8Z2090	ZEN	A1450 X B500 X C500	45,1	326

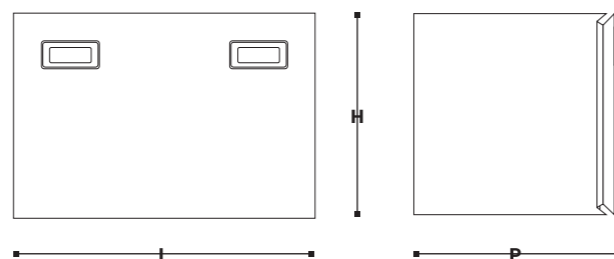

Cassetta porta attrezzi in acciaio inox opaco Z22-Z23

MANIGLIA NEXT



ARTICOLO	LINEA	FORMATO (mm)	PESO kg	CAPACITÀ lt
8Z2200	ZEN	A400 X B300 X C300	8,9	32
8Z2210	ZEN	A500 X B350 X C400	14,6	63
8Z2220	ZEN	A600 X B400 X C500	22,3	108
8Z2221	ZEN	A600 X B600 X C600	27,9	194
8Z2240	ZEN	A800 X B500 X C500	28,1	180
8Z2243	ZEN	A800 X B600 X C600	34,6	259
8Z2260	ZEN	A1000 X B500 X C500	33,4	225
8Z2263	ZEN	A1000 X B600 X C600	40,6	324
8Z2280	ZEN	A1200 X B500 X C500	38,6	270
8Z2290	ZEN	A1450 X B500 X C500	45,1	326

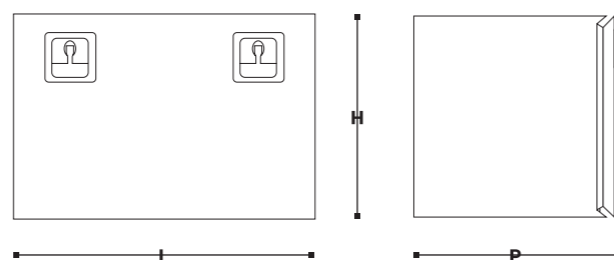

Cassetta porta attrezzi in acciaio inox opaco Z24/25

MANIGLIA NEXT NYLON



ARTICOLO	LINEA	FORMATO (mm)	PESO kg	CAPACITÀ lt
8Z2400	ZEN	A400 X B300 X C300	8,9	32
8Z2410	ZEN	A500 X B350 X C400	14,6	63
8Z2420	ZEN	A600 X B400 X C500	22,3	108
8Z2421	ZEN	A600 X B600 X C600	27,9	194
8Z2440	ZEN	A800 X B500 X C500	28,1	180
8Z2443	ZEN	A800 X B600 X C600	34,6	259
8Z2460	ZEN	A1000 X B500 X C500	33,4	225
8Z2463	ZEN	A1000 X B600 X C600	40,6	324
8Z2480	ZEN	A1200 X B500 X C500	38,6	270
8Z2490	ZEN	A1450 X B500 X C500	45,1	326

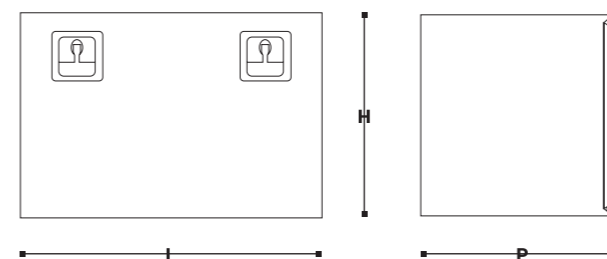

Cassetta porta attrezzi in acciaio verniciato Z30/31

MANIGLIA NEXT NYLON



ARTICOLO	LINEA	FORMATO (mm)	PESO kg	CAPACITÀ lt
8Z3000	ZEN	A400 X B300 X C300	8,9	32
8Z3010	ZEN	A500 X B350 X C400	14,6	63
8Z3020	ZEN	A600 X B400 X C500	22,3	108
8Z3021	ZEN	A600 X B600 X C600	27,9	194
8Z3040	ZEN	A800 X B500 X C500	28,1	180
8Z3043	ZEN	A800 X B600 X C600	34,6	259
8Z3060	ZEN	A1000 X B500 X C500	33,4	225
8Z3063	ZEN	A1000 X B600 X C600	40,6	324
8Z3080	ZEN	A1200 X B500 X C500	38,6	270
8Z3090	ZEN	A1450 X B500 X C500	45,1	326

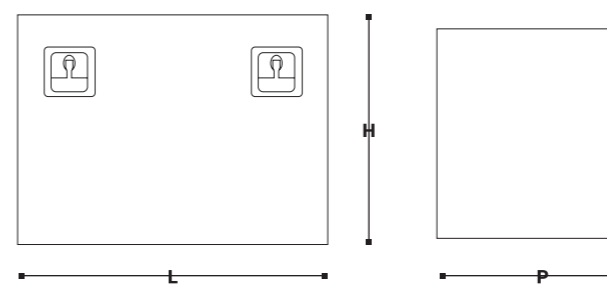

Cassetta zincata standard

MANIGLIA EUROPLEX IN NYLON



La fabbricazione avviene mediante saldatura a resistenza. Molti gli accessori disponibili per la personalizzazione del prodotto.

Cassetta porta attrezzi della linea ZEN Basic. Più leggera ma resistente grazie all'utilizzo di rivetti strutturali e al design del coperchio. Unica nel suo genere e nella funzionalità, la cassetta porta attrezzi rivettata Daken è brevettata.

ARTICOLO	LINEA	FORMATO (mm)	PESO kg	CAPACITÀ lt
8B1111	ZEN BASIC	L500 X H300 X P400	6,6	60
8B1101	ZEN BASIC	L400 X H300 X P300	4,8	32
8B1120	ZEN BASIC	L600 X H400 X P500	10	108

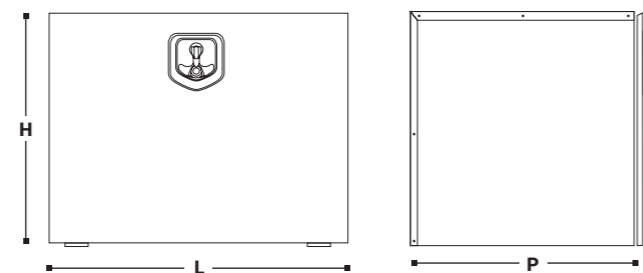

CARATTERISTICHE

Cassetta zincata standard

MANIGLIA NEXT NYLON



ARTICOLO	LINEA	FORMATO (mm)	PESO kg	CAPACITÀ lt
8B1141	ZEN BASIC	L800 X H500 X P500	14,3	180
8B1160	ZEN BASIC	L1000 X H500 X P500	17	225

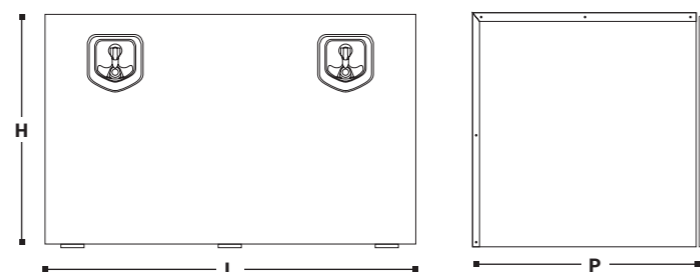

Cassetta in acciaio inox fiorettata

MANIGLIA NEXT NYLON



ARTICOLO	LINEA	FORMATO (mm)	PESO kg	CAPACITÀ lt
8B6001	ZEN BASIC	L400 X H300 X P300	6	32
8B6011	ZEN BASIC	L500 X H300 X P400	8,2	60
8B6020	ZEN BASIC	L600 X H400 X P500	12,7	180
8B6040	ZEN BASIC	L800 X H400 X P400	13,7	115

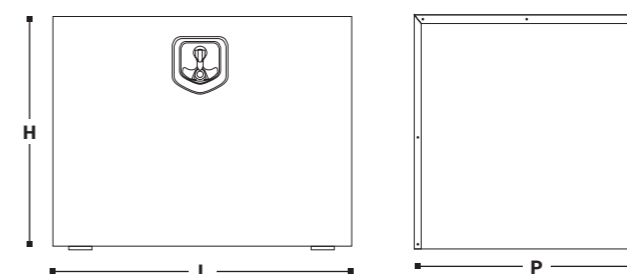

- FINITURA: Acciaio inox fiorettato AISI 304
- SPESSORE: 0,8 mm – 1,0 mm
- CHIUSURA: Maniglia Europlex in nylon
- MATERIALE CERNIERE: Acciaio Inox

Cassetta porta attrezzi della linea ZEN Basic. Più leggera ma resistente grazie all'utilizzo di rivetti strutturali e al design del coperchio. Unica nel suo genere e nella funzionalità, la cassetta porta attrezzi rivettata Daken è brevettata.

ARTICOLO	LINEA	FORMATO (mm)	PESO kg	CAPACITÀ lt
8B6041	ZEN BASIC	L800 X H500 X P500	18	180
8B6060	ZEN BASIC	L1000 X H500 X P500	21	225

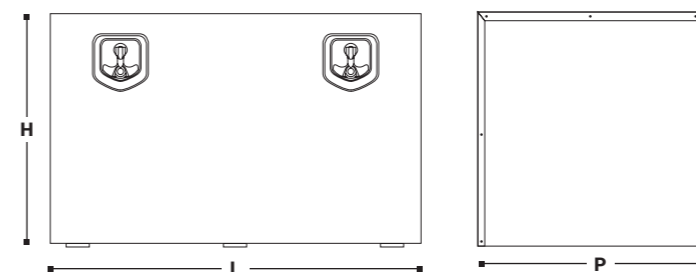

Cassetta in acciaio inox fiorettata

MANIGLIA NEXT NYLON



Porta pallet in acciaio zincato

3 CHIUSURE A LACCIO
PER OGNI LATO

ARTICOLO	LINEA	FORMATO (mm)	N. EPAL	PESO kg
8Z8050	ZEN	A3554 X B504 X C2434	32	400
8Z8060	ZEN	A2754 X B698 X C2434	36	355
8Z8061	ZEN	A3354 X B648 X B2434	36	410

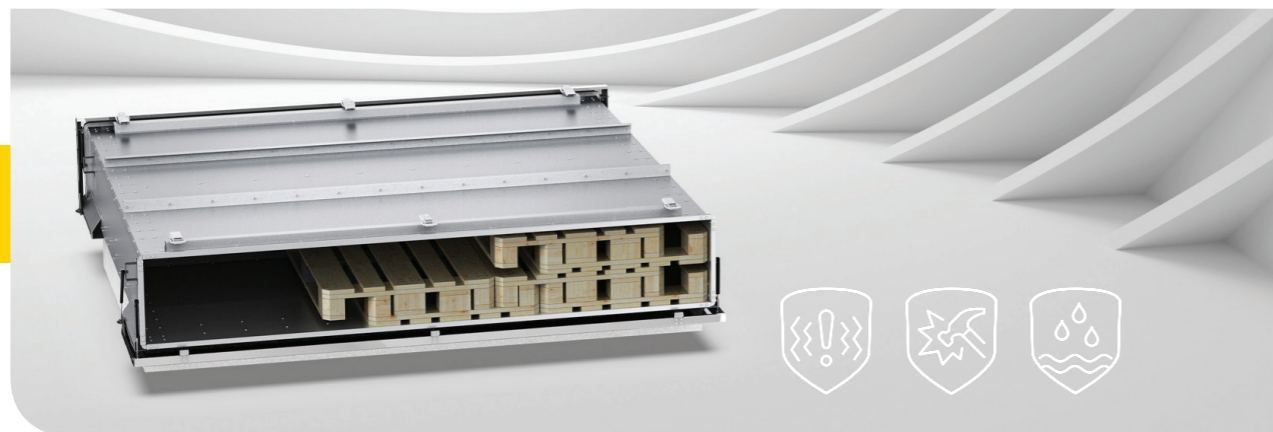
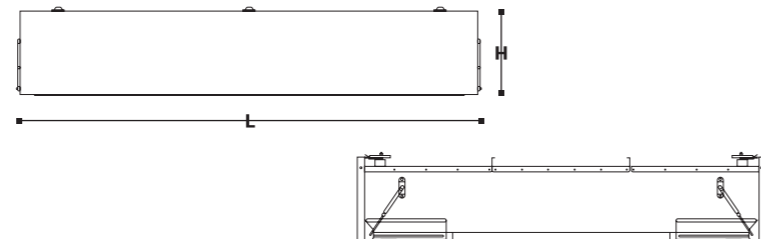
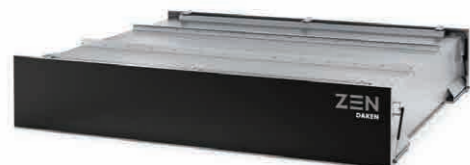

FINITURE

- ACCIAIO ELETTROZINCATO VERNICIATO A POLVERE EPOSSIDICA BIANCA
- ACCIAIO ELETTROZINCATO VERNICIATO A POLVERE
- ACCIAIO INOX LUCIDO AISI 304 BA EPOSSIDICA NERA
- ACCIAIO INOX LUCIDO AISI 304 2B
- ACCIAIO ZINCATO DX51D-Z140



ARTICOLO	LINEA	FORMATO (mm)	CAPACITÀ	CARICO kg
V6980S	V9	2750 x 700 x 2425	36 EP	150

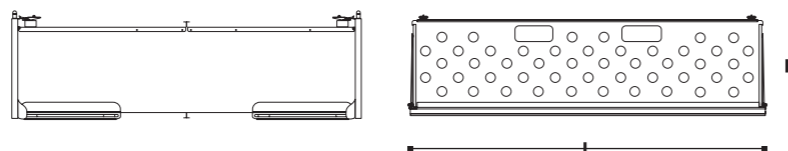

FINITURE

- ACCIAIO INOX OPACO AISI 304 2B / MANIGLIA NEXT IN ACCIAIO INOX AISI 304
- ACCIAIO ELETTROZINCATO VERNICIATO A POLVERE EPOSSIDICA COLORE NERO

L'innovativo Porta Transpallet ZEN, dotato di rampa estraibile, smorzatori e rulliera antigraffio brevettata, per agevolare le operazioni di carico e scarico.

ARTICOLO	LINEA	DIMENSIONI ESTERNE (mm)	PESO kg
8Z8520	ZEN	A670 X B650 X P1600	60
8Z8540	ZEN	A820 X B650 X P1600	70

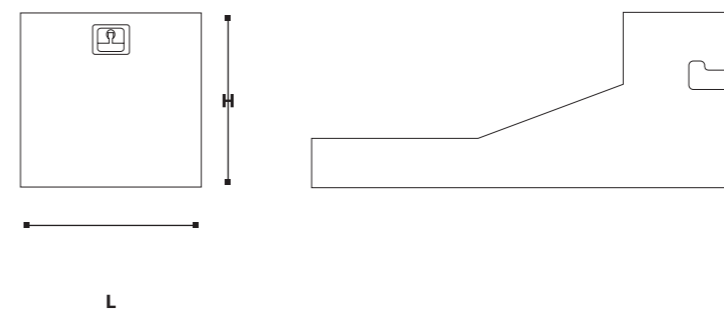

Porta transpallet in acciaio

MANIGLIA NEXT IN NYLON





Staffe in acciaio zincato a freddo

CON KIT VITERIA

LINEA VERTICALE:

ARKA / WELVET / JUST / SLIDEN

LINEA ORIZZONTALE:

WELVET 81000 - 81002 / JUST 81100 - 81102 - 81105 / ARKA 81205 - 81206 - 81208 - 81209 / WELVET 81004 - 81006 - 81008 / JUST 81104 - 81106 - 81108 - 81110 - 81111 / FLINK 81305



ARTICOLO	MARCA	SPESSORE (mm)	PESO kg	CARICO kg
88401	DAKEN	6	1,7	200



ARTICOLO	MARCA	SPESSORE (mm)	PESO kg	CARICO kg
88411	DAKEN	2	2,1	150



ARTICOLO	MARCA	SPESSORE (mm)	PESO kg	CARICO kg
88463	DAKEN	2	2,3	150
88473	DAKEN	2,4	3,3	150



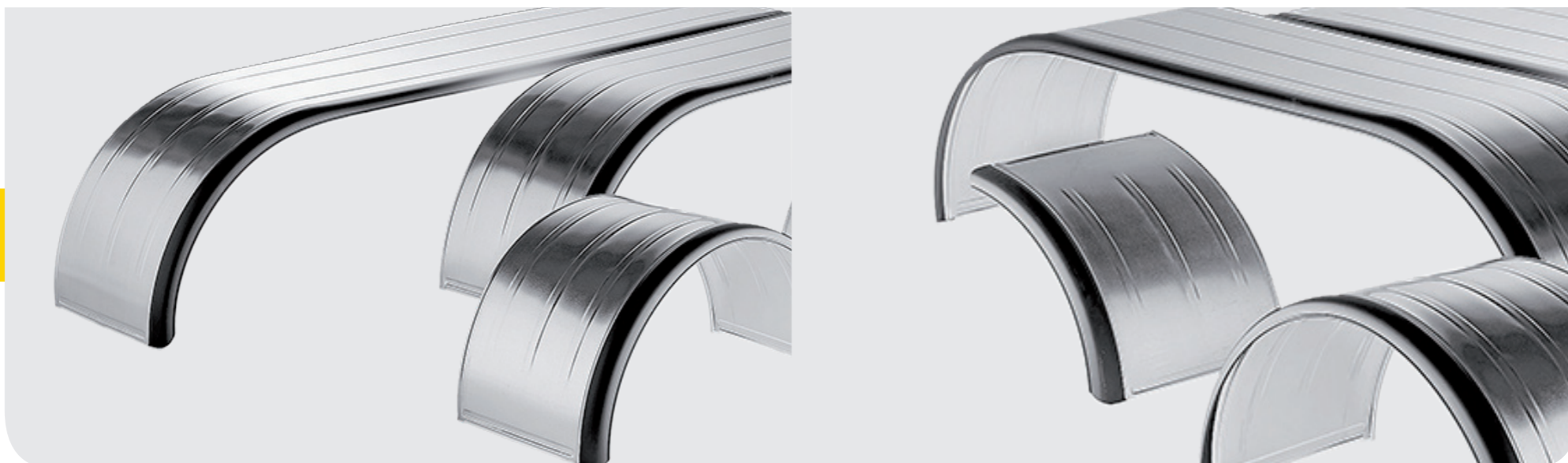

Parafanghi

ZINCO GOMMA

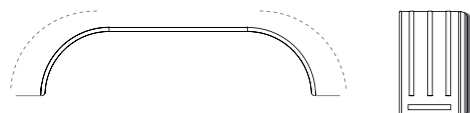

ARTICOLO	LINEA	FORMATO (mm)	E	H
10 13 11 315	LAGO	A3500 X B2740 X C650	90	670
10 13 11 310	LAGO	A3500 X B2740 X C650	90	670
10 13 11 335	LAGO	A3500 X B2740 X C650	90	670
10 13 11 340	LAGO	A3500 X B2740 X C650	90	670

ARTICOLO	LINEA	FORMATO (mm)	E	H
10 13 11 380	LAGO	A2100 X B1340 X C650	90	670
10 13 11 400	LAGO	A2100 X B1340 X C450	90	670
10 13 11 435	LAGO	A2000 X B1260 X C550	90	630
10 13 11 485	LAGO	A3500 X B2740 X C650	90	585
10 13 11 490	LAGO	A3500 X B2740 X C600	90	585

10 13 21 515	LAGO	A1700 X B1100 X C550	90	500
10 13 21 560	LAGO	A1570 X B1100 X C550	90	500
10 13 21 565	LAGO	A1570 X B1000 X C500	90	490
10 13 21 570	LAGO	A1570 X B980 X C450	90	490
10 13 21 625	LAGO	A1450 X B880 X C400	90	440
10 13 21 630	LAGO	A1450 X B880 X C270	90	440

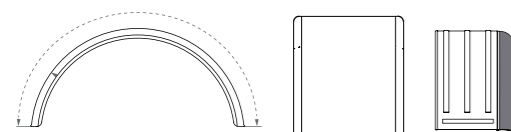

10 13 21 515	LAGO	A1700 X B1100 X C550	90	500
10 13 21 560	LAGO	A1570 X B1100 X C550	90	500
10 13 21 565	LAGO	A1570 X B1000 X C500	90	490

ARTICOLO	LINEA	FORMATO (mm)	E	H
10 13 20 130	LAGO	A800 X B - X C650	90	650
10 13 20 165	LAGO	A700 X B - X C500	90	650

Parafanghi

ZINCO GOMMA

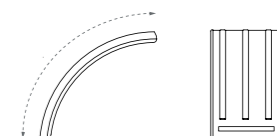

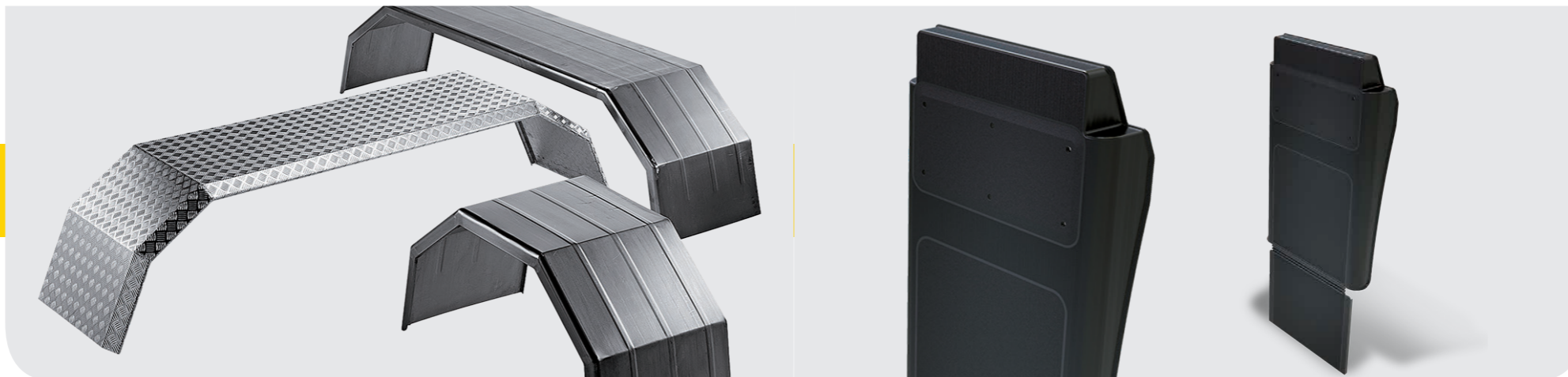

Parafanghi per mezzi d'opera

SPIGOLATI

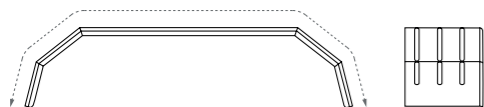

ARTICOLO	LINEA	FORMATO (mm)	S	H
10 25 26 315	LAGO	A3500 X B2740 X C650	1,8	660
10 30 26 315	LAGO	A3500 X B2740 X C650	1,5	660
10 32 26 315	LAGO	A3500 X B2740 X C650	1,5	660
10 46 26 315	LAGO	A3500 X B2740 X C650	3+2	660

Parafango dritto c/paraspruzzo integrato

POLIPROPILENE

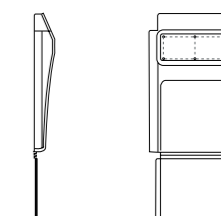

ARTICOLO	LINEA	FORMATO (mm)	C	R	H	KG
15 60 40 010	LAGO	A735 X B470 b410	110	670	-	1,8
15 60 40 015	LAGO	A735 X B470 b410	110	670	155	2
15 60 40 018	LAGO	A735 X B470 b410	110	670	190	2,2
15 60 40 020	LAGO	A735 X B470 b410	110	670	265	2,3
15 60 40 025	LAGO	A735 X B470 b410	110	670	350	2,4
15 60 39 025	LAGO	A620 X B480 b410	110	670	290	3,0

PERSONALIZZAZIONE

DIMENSIONE AREA 68x15 mm





Parafanghi curvi, mezzi e sommità piatta

POLIPROPILENE

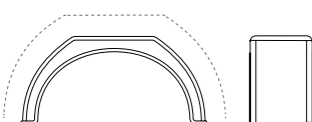
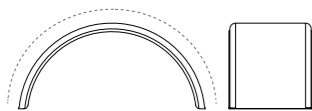

ARTICOLO	LINEA	FORMATO (mm)	R	KG
11 60 41 380	LAGO	A2100 X B1340 X C660	670	6,1
11 60 41 410	LAGO	A2100 X B1350 X C440	670	4,2
11 60 41 465	LAGO	A1900 X B1250 X C650	670	5,8
11 60 41 460	LAGO	A1920 X B1310 X C450	650	3,5
11 60 41 505	LAGO	A1700X B1100 X C560	550	3,5
11 60 41 535	LAGO	A1580 X B1000 X C550	500	3
11 60 41 540	LAGO	A1580 X B1000 X C500	500	2,8
11 60 41 640	LAGO	A1400 X B900 X C450	450	2,3
11 60 41 655	LAGO	A1380 X B890 X C400	440	2

11 60 42 610	LAGO	A1470 X B910 X C460	500	2,6
11 60 42 600	LAGO	A2100 X B1350 X C440	670	2,4

11 60 40 080	LAGO	A1000 X B - X C660	670	3
11 60 40 095	LAGO	A1000 X B - X C440	670	2
11 60 40 130	LAGO	A800 X B - X C670	670	2,1
11 60 40 145	LAGO	A810 X B - X C440	670	1,5
11 60 40 155	LAGO	A700 X B - X C670	670	2
11 60 40 170	LAGO	A700 X B - X C440	670	1,4
11 60 01 010	LAGO	A640 X B - X C720	640	2

ARTICOLO	LINEA	FORMATO (mm)	R	KG
11 60 46 380	LAGO	A2100 X B1340 X C660	670	7,6
11 60 46 410	LAGO	A2100 X B1350 X C440	670	5,7
11 60 46 465	LAGO	A1900 X B1330 X C650	670	7,3
11 60 46 460	LAGO	A1940 X B1310 X C450	650	5
11 60 46 505	LAGO	A1700X B1100 X C560	550	5
11 60 46 535	LAGO	A1580 X B1000 X C550	500	4,5
11 60 46 540	LAGO	A1580 X B1000 X C500	500	4,3
11 60 46 640	LAGO	A1400 X B900 X C450	450	3,8
11 60 46 655	LAGO	A1380 X B890 X C400	440	3,5

11 60 45 130	LAGO	A800 X B - X C670	670	2,1
11 60 45 145	LAGO	A810 X B - X C440	670	3
11 60 45 155	LAGO	A700 X B - X C670	670	3,5
11 60 45 170	LAGO	A700 X B - X C440	670	2,9
11 60 01 037	LAGO	A640 X B - X C720	670	3,5

Parafanghi con staffe assemblate

POLIPROPILENE

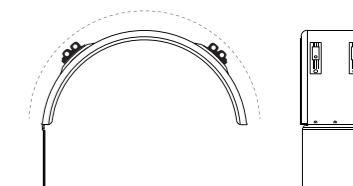

PERSONALIZZAZIONE

DIMENSIONE AREA 68x15 mm

PERSONALIZZAZIONE

DIMENSIONE AREA 68x15 mm





Parafango c/paraspruzzo integrato

POLIPROPILENE

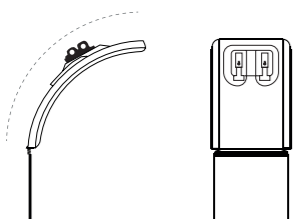

ARTICOLO	LINEA	FORMATO (mm)	H	R	KG
15 60 01 008	LAGO	A700 X B450 b390	-	670	1,78
15 60 10 170	LAGO	A700 X B450 b390	160	670	2,75
15 60 11 170	LAGO	A700 X B450 b390	250	670	3
15 60 12 170	LAGO	A700 X B450 b390	350	670	3,5
15 60 09 170	LAGO	A700 X B450 b390	300	670	3

Paraspruzzo c/ anti spray

POLIPROPILENE

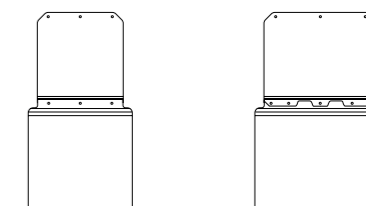

ARTICOLO	LINEA	FORMATO (mm)	H	C	KG
12 60 64 210	LAGO	A780 X B340 b412	400	127	1,6
12 60 64 215	LAGO	A780 X B436 b508	400	175	2
12 60 64 220	LAGO	A780 X B532 b604	400	223	2,4

PERSONALIZZAZIONE

DIMENSIONE AREA 330x190 mm

PERSONALIZZAZIONE

DIMENSIONE AREA 330x190 mm

Staffe e sistemi di fissaggio per parafanghi

Tubi, attacchi e kit di fissaggio

Supporti a pianale o telaio per cassette porta attrezzi, tubi e sistemi di fissaggio per parafanghi, finiture e spessori che rispondono alle diverse esigenze di montaggio. Un'offerta completa progettata con la massima attenzione perchè i nostri prodotti possano garantire la migliore prestazione, nel tempo.



ARTICOLO

Tubo dritto Ø54x2 L.750 zincato
+1 staffa saldata e 1 mobile zincate

72268

ARTICOLO

Tubo dritto Ø42x2 L.600 zincato
+1 staffa saldata e 1 mobile zincate

72280



ARTICOLO

Attacco zincato Ø54 con flangia quadra

72269

ARTICOLO

Attacco zincato Ø42 con flangia tonda

72270

Staffe e sistemi di fissaggio per parafanghi

Tubi, attacchi e kit di fissaggio

MATERIALE
Acciaio S235JR zincato
Verniciato

ARTICOLO

Tubo dritto zincato Ø42x2 flangia
triangolare L.750

72275



ARTICOLO

Tubo verniciato d.42 c/flangia triangolare

72275



ARTICOLO

Tubo 2 curve zincato Ø42x2
flangia tonda L.735

181110105

181110115



ARTICOLO

TUBO VERNICIATO D.42 C/FLANGIA
TRIANGOLARE NERO

181610105



ARTICOLO

TUBO VERNICIATO NERO D.42 L 800mm
TONDO C/BULLONE

72279



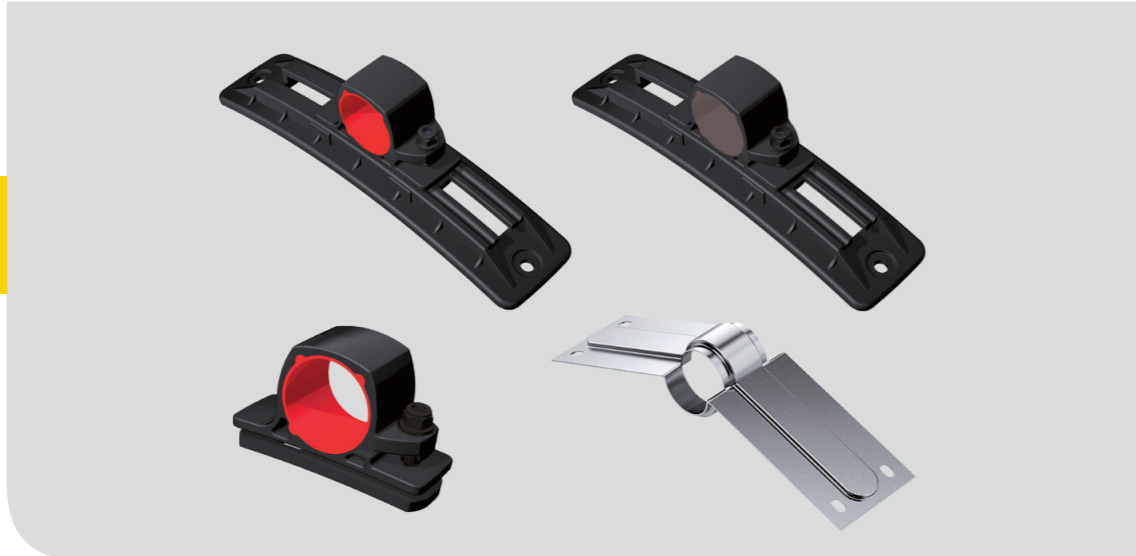

Staffe e sistemi di fissaggio per parafanghi

MATERIALE

PA6 Nylon fibra vetro, gomma EPDM
Acciaio S235JR zincato
Acciaio inox AISI 304 2B

Supporti a pianale o telaio per cassette porta attrezzi, tubi e sistemi di fissaggio per parafanghi, finiture e spessori che rispondono alle diverse esigenze di montaggio. Un'offerta completa progettata con la massima attenzione perchè i nostri prodotti possano garantire la migliore prestazione, nel tempo.



ARTICOLO

72276

Staffa termoplastica regolabile Ø42 - occhiello grip rosso



ARTICOLO

60167110

Staffa regolabile zincato Ø42



Kit Standard

TUBO IN PLASTICA
CON CAVALLOTTI Ø42

TUBO IN PLASTICA Ø42 L690



VITE TE M16X90 ZNB Ø 17X48
FASCIA LARGA UNI5739



RONDELLA PIANA ZNB Ø 17X48
FASCIA LARGA UNI6593



TAPPO IN PLASTICA



CAVALLOTTO IN PLASTICA



VITE IN PLASTICA M12



DADO IN PLASTICA



Coppia staffe per tanica in plastica

ZINCATE

COMPATIBILITÀ: articolo 601000400/ TK2525

ARTICOLO	MARCA	PRODOTTO	FORMATO (mm)	PESO kg
601200200	LOKHEN	SQUARE	L414X B68 X H159	2,50

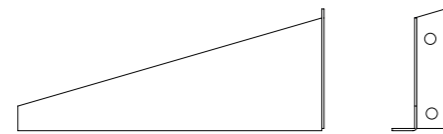
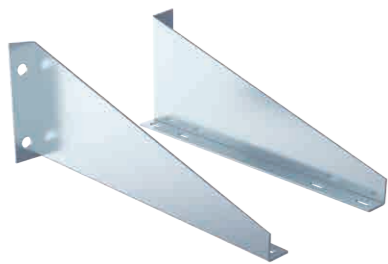

COMPATIBILE PER I MODELLI **SQUARE** E **GALLERY**

ARTICOLO	MARCA	PRODOTTO	FORMATO (mm)	PESO kg
601200400	LOKHEN	SQUARE	L200X B73 X H158	1,40

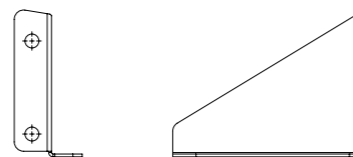
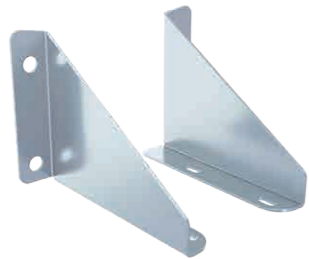

COMPATIBILE CON TUTTI I TIPI DI CAMION, AUTO, RIMORCHI, TRATTORI E PIATTAFORME.

VOLUME 18 lt / 25 lt / 28 lt

CON ELEMENTI DI FISSAGGIO

ARTICOLO	MARCA	PRODOTTO	FORMATO (mm)	PESO kg
601000400	LOKHEN	SQUARE	L421 X B342,5 X H332	2,78

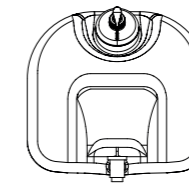
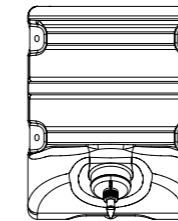

ARTICOLO	MARCA	PRODOTTO	FORMATO (mm)	PESO kg
601040400	LOKHEN	SQUARE	L330 X B330 X H332	2,15

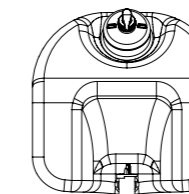
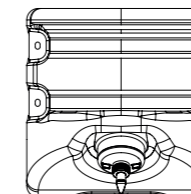

ARTICOLO	MARCA	PRODOTTO	FORMATO (mm)	PESO kg
601010400	LOKHEN	GALLERY	L458,5 X B352 X H379	1,9

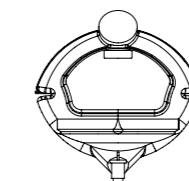
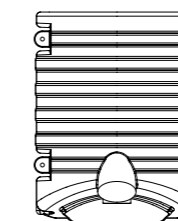

Serbatoi acqua in plastica

COLORE NERO



Tanica acqua in lamiera

FIORETTATA

ACCIAIO INOX AISI 304/X5CRNI18-10/1.4301-2B;
SPESSORE: 0,1 MM;
SALDATURA TIG QUALIFICATO



ARTICOLO	CAPACITÀ	FORMATO (mm)	PESO kg
8Z0531	25	170 X 360 X 410	5,3



STAFFA DI FISSAGGIO **DIETRO**

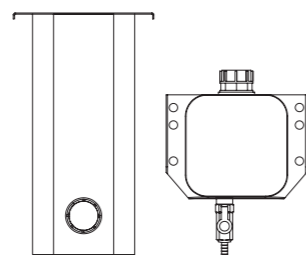

ARTICOLO	CAPACITÀ	FORMATO (mm)	PESO kg
8Z0531000	25	170 X 360 X 410	5,3



STAFFA DI FISSAGGIO **SOTTO**

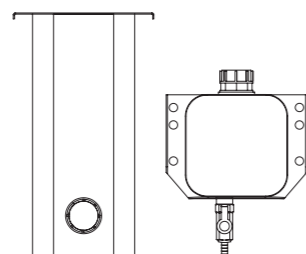

Tanica acqua in lamiera

FIORETTATA



ACCIAIO INOX AISI 304/X5CRNI18-10/1.4301-2B;
SPESSORE: 0,1 MM;
SALDATURA TIG QUALIFICATO

ARTICOLO	CAPACITÀ	FORMATO (mm)	PESO kg
8Z0510	12	170 X 180 X 410	2,8



STAFFA DI FISSAGGIO **DIETRO**

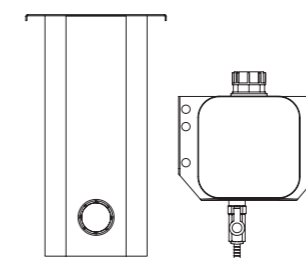

ARTICOLO	CAPACITÀ	FORMATO (mm)	PESO kg
8Z0510000	12	170 X 180 X 410	2,8



STAFFA DI FISSAGGIO **SOTTO**

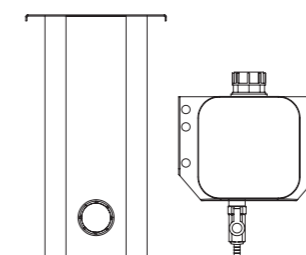

Tanica acqua in lamiera

FIORETTATA

ACCIAIO INOX AISI 304/X5CRNI18-10/1.4301-2B;
 SPESSORE: 0,1 MM;
 SALDATURA TIG QUALIFICATO



ARTICOLO	CAPACITÀ	FORMATO (mm)	PESO kg
8Z0530	25	280 X 250 X 370	4,4

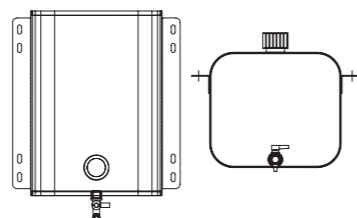

ARTICOLO	CAPACITÀ	FORMATO (mm)	PESO kg
TA902803	25	170 X 170 X 400	4

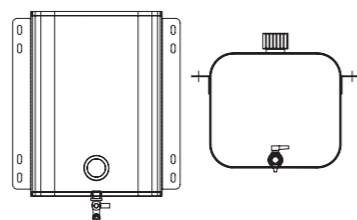

i FORMATO PICCOLO

Tanica per scarico liquami

FIORETTATA

LA FABBRICAZIONE AVVIENE TRAMITE IL PROCESSO DI SALDATURA LASER E/O TIG QUALIFICATO.
 SPESSORE: 0,1 MM;

ARTICOLO	FORMATO (mm)	LT
TA911010	250X200X200	10

ARTICOLO	FORMATO (mm)	LT
TA911010	250X200X200	10

ARTICOLO	FORMATO (mm)	LT
V9110	300X250X250	18

ARTICOLO	FORMATO (mm)	LT
V9115	390X260X285	28

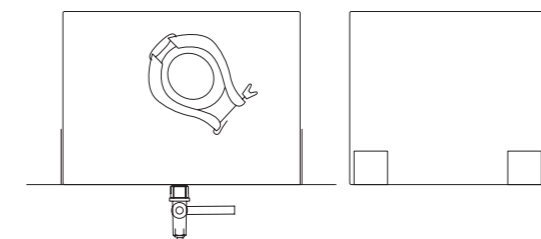
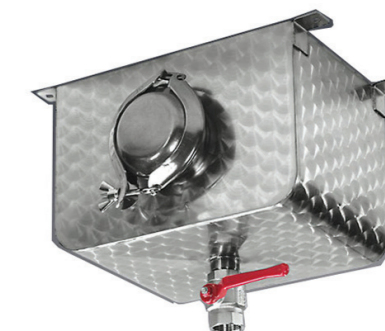

Barra paraincastri verniciate

COLORE ANTRACITE



CON TESTATA IN PLASTICA

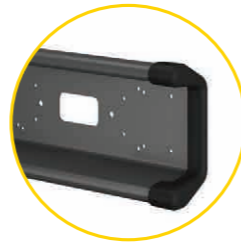

ARTICOLO	MARCA	FORMATO (mm)	PESO kg
TK 7510	TAKLER	L1800 X B228 X H106 X S129	10,5
TK 7515	TAKLER	L1900 X B228 X H106 X S129	11,1
TK 7520	TAKLER	L2000 X B228 X H106 X S129	11,7
TK 7525	TAKLER	L2100 X B228 X H106 X S129	12,3
TK 7530	TAKLER	L2200 X B228 X H106 X S129	12,9
TK 7535	TAKLER	L2300 X B228 X H106 X S129	13,5
TK 7540	TAKLER	L2400 X B228 X H106 X S129	14,1

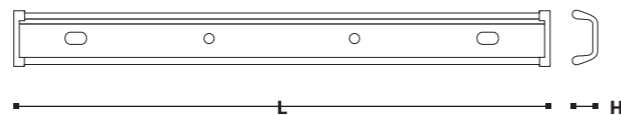

LE NUMEROSE VERSIONI DISPONIBILI CONSENTONO IL POSIZIONAMENTO DELLA TARGA SIA CENTRALMENTE CHE LATERALMENTE.

Barre paraincastri inox fiorettato

TARGA CENTRALE



ARTICOLO	MARCA	FORMATO (mm)	SPES. (mm)	PESO kg
V8515	BAWER	1900	1,5	9,48
V8520	BAWER	2000	1,5	9,48
V8525	BAWER	2100	1,5	10,48
V8530	BAWER	2200	1,5	10,98
V8535	BAWER	2300	1,5	11,48
V8540	BAWER	2400	1,5	11,98

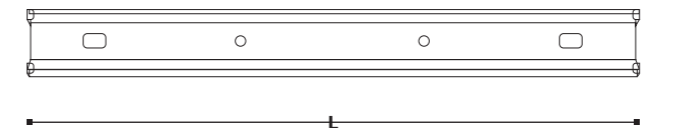

Barra paraincastri verniciate

COLORE GRIGIO



CON TESTATA IN PLASTICA

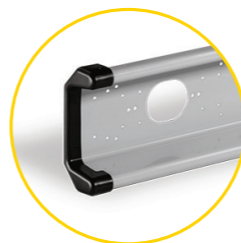

ARTICOLO	MARCA	FORMATO (mm)	PESO kg
351821130	LAGO	L2400 X H430 X S2	21,6

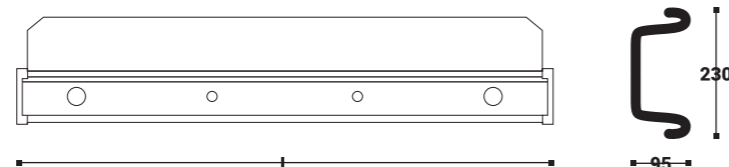

ARTICOLO	MARCA	FORMATO (mm)	SPES. (mm)	PESO kg
V8550	BAWER	2300	1,5	17,25
V8555	BAWER	2400	1,5	18

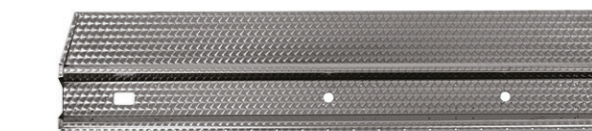
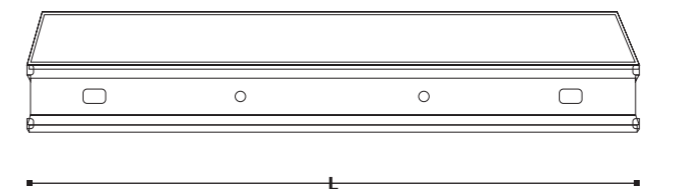

Staffe per Paracicli

CON KIT VITERIA

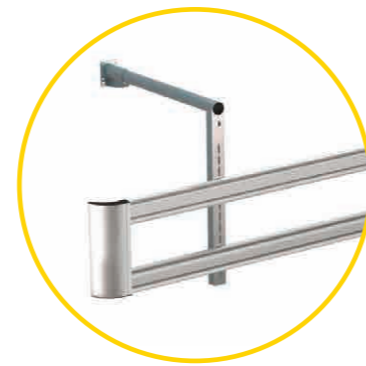

ARTICOLO	DIMENSIONI (mm)	DIAMETRO	PESO	CARICO
TK 3052	L 600 X H 492	42 mm	1,9 kg	100 kg
TK 3054	L 800 X H 800	54 mm	3,5 kg	100 kg

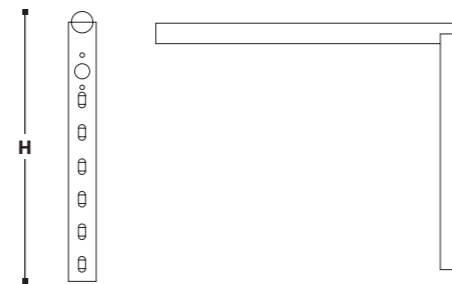

ARTICOLO	LINEA	FORMATO (mm)	H	PESO
TK 3023	TAKLER	L 54.7 - B 140 - H 572 - S 155	572 mm	1,8 kg
TL2301712	TAKLER	L 54.7 - B 140 - H 710 - S 155	710 mm	2 kg

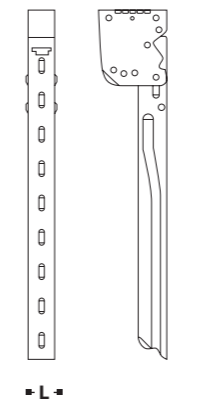

Supporto Paracicli registrabile

PROTEZIONE LATERALE



Angolari alluminio anodizzato

COMPLETO DI TAPPI

TESTATA IN ALLUMINIO
PER BARRE DI PROTEZIONE
LATERALE

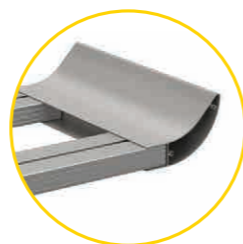

ARTICOLO	MARCA	FORMATO (mm)	PESO kg
TK 1330	TAKLER	L140 X B100 X H400	0,6
TK 1340	TAKLER	L140 X B100 X H500	0,8

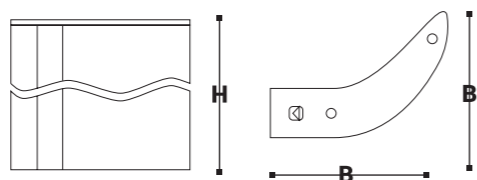

PER BARRE DI PROTEZIONE
LATERALE IN ALLUMINIO

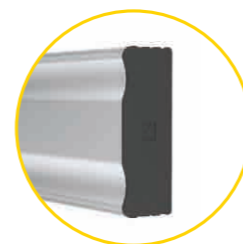

ARTICOLO	MARCA	FORMATO (mm)	PESO kg	COLORE
TK 1380	TAKLER	L3 X B35 X H100	0,04	NERO
TK 1375	TAKLER	L3 X B35 X H100	0,04	GRIGIO

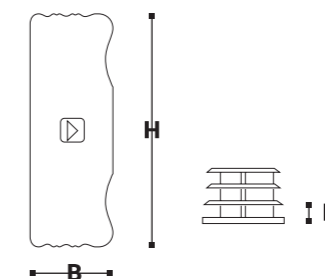

Tappo in plastica

2 COLORI



Dispositivo di protezione laterale

IN ALLUMINIO

BARRA PROTEZIONE
LATERALE IN ALLUMINIO
ANODIZZATO

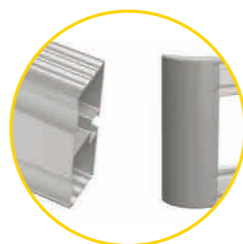

ARTICOLO	MARCA	FORMATO (mm)	PESO kg
TK 1240	TAKLER	L6500 X B35 X H100	7,4

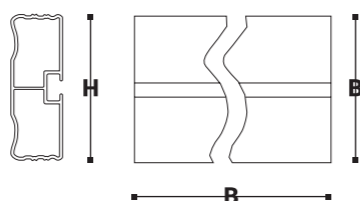

PER BARRE DI PROTEZIONE
LATERALE IN ALLUMINIO

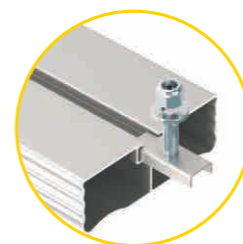

ARTICOLO	MARCA	FORMATO (mm)	PESO kg
TK 1390	TAKLER	L40 X B16,4 X H6,2	0,03

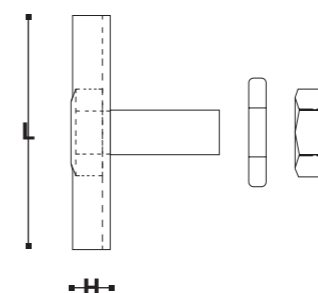

Kit di fissaggio per barra di protezione laterale

IN ALLUMINIO

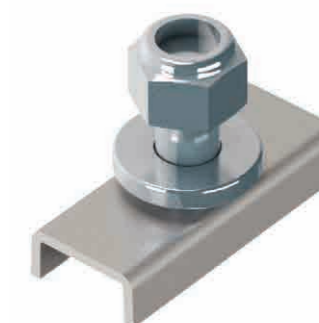

CERTIFICAZIONI conforme alla normativa | omologato
89/297/CEE;R73;E1173R-011025;E1173R-011028

Calzatoia gialla termoplastica

CON INSERTO



ARTICOLO	LINEA	FORMATO (mm)	PESO kg
610110204	NET 53	L467 X B198 X H225 X R555	1,41
600000200	NET 46	L383 X B160 X H190 X R460	0,75
600090200	NET 36	L336 X B123 X H148 X R355	0,40

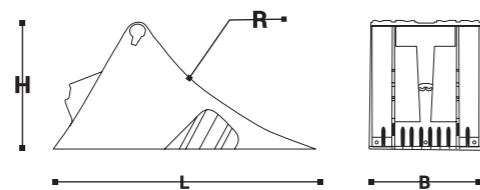

CARATTERISTICHE

CINGHIA TERMOPLASTICA OMOLOGATA E53
 CIONDOLO TERMOPLASTICO GIALLO OMOLOGATO G46
 CALZATOIA OMOLOGATA TERMOLASTICA OMOLOGATA 53

Calzatoia gialla termoplastica

RICHIUDIBILE



ARTICOLO	LINEA	FORMATO (mm)	PESO kg
600500100	ORIGAMY	L472 X B199 X H230 X R560	0,96

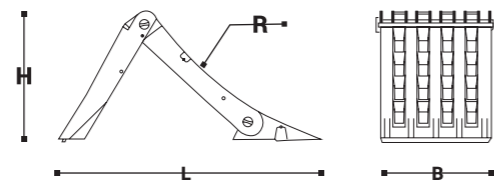

Supporto di fissaggio singolo

ALLUMINIO ANODIZZATO



GUARNIZIONE IN PVC COESTRUSO RIGIDO
 IN PVC GOMMA DA 3,2 MT PER PORTE
 POSTERIORI E LATERALI

ARTICOLO	MARCA	PRODOTTO	FORMATO (mm)	PESO kg
600740100	LOKHEN	ALOK SINGLE	L69 X B65 X H35	0,16

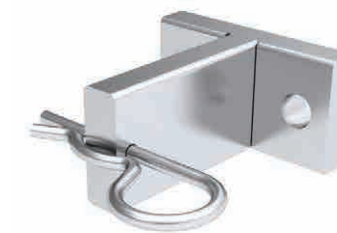
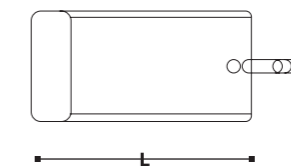
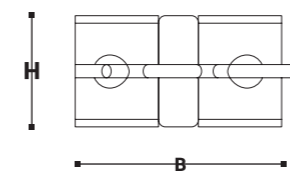

Supporto di fissaggio doppio

ALLUMINIO ANODIZZATO



GUARNIZIONE IN PVC COESTRUSO RIGIDO
 IN PVC GOMMA DA 3,2 MT PER PORTE
 POSTERIORI E LATERALI

ARTICOLO	MARCA	PRODOTTO	FORMATO (mm)	PESO kg
620740200	LOKHEN	ALOK DOUBLE	L126 X B65 X H35	0,23

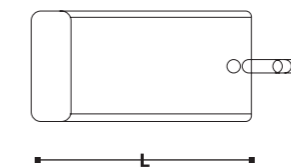
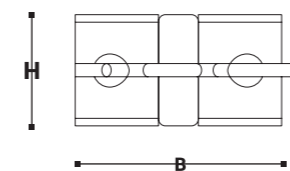

Porta calzatoia zincato

A FREDDO



ARTICOLO	MARCA	PRODOTTO	FORMATO (mm)	PESO kg
600170600	LOKHEN	PORTA CHOCK E53	L208 X B171 X H228	0,91

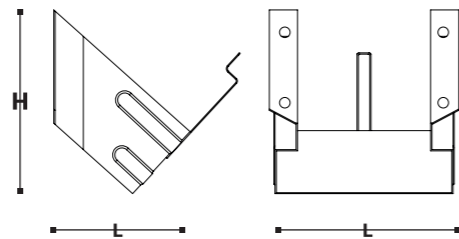

ARTICOLO	MARCA	PRODOTTO	FORMATO (mm)	PESO KG
600210100	LOKHEN	DOUBLE G46	L133 X B124 X H109	0,17

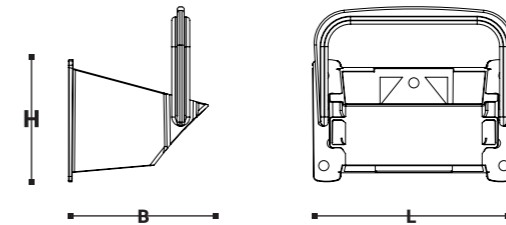

Porta calzatoia in plastica E36

PLASTICA NERA



Porta calzatoia in Magnelis

CON MOLLA IN PVC

PER BARRE DI PROTEZIONE
LATERALE IN ALLUMINIO



ARTICOLO	MARCA	PRODOTTO	FORMATO (mm)	PESO kg
600710100	LOKHEN	BOX	L314 X B166 X H235	1,54

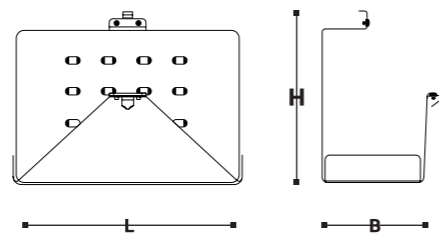

ARTICOLO	MARCA	PRODOTTO	FORMATO (mm)	PESO KG
600150100	LOKHEN	HOST G46	L184 X B194 X H128	0,45
600180100	LOKHEN	HOST E53	L213 X B183 X H137	0,44

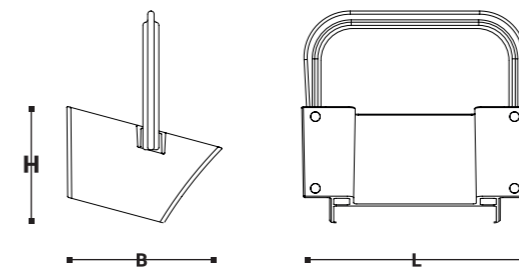

Porta calzatoia in plastica

SMALL/BIG



Profili termoplastici in PVC

RIGIDO

GUARNIZIONE IN PVC COESTRUSO RIGIDO
IN PVC GOMMA DA 3,2 MT PER PORTE
POSTERIORI E LATERALI

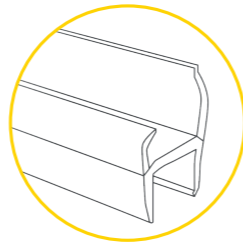

ARTICOLO	MARCA	FORMATO (mm)	PESO kg
602000100	LOKHEN	L27 X B19 X H12	1,5
602000400	LOKHEN	L33 X B30 X H15	1,5

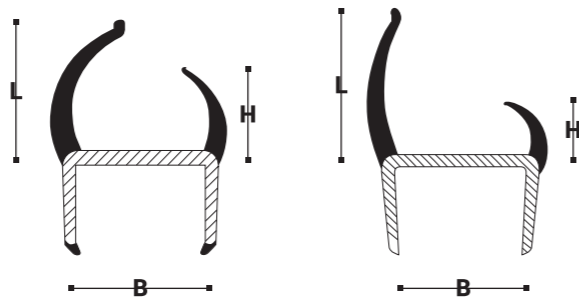

ARTICOLO	MARCA	FORMATO (mm)	PESO kg
602010300	LOKHEN	L46 X B47 X H32 X P21	2,11

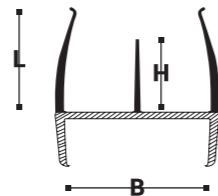

Profili in gomma per tetto

PROFILO PVC GOMMA 14 MT
PER TETTO SCORREVOLE

ARTICOLO	MARCA	FORMATO (mm)	PESO kg
602020100	LOKHEN	L6,3 X B120 X H17,3	9,1



ARTICOLO	MARCA	FORMATO (mm)	PESO kg
602020200	LOKHEN	L5,9 X B100 X H38	7,87

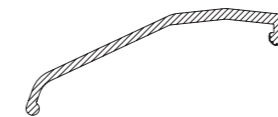

ARTICOLO	MARCA	FORMATO (mm)	PESO kg
602020300	LOKHEN	L6 X B135 X H45	11,5

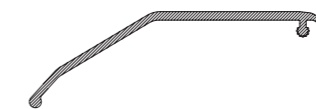

Porta documenti

IN PLASTICA



• Porta documenti a destra

ARTICOLO	MARCA	FORMATO (mm)	PESO kg	COLORE
603010100	LOKHEN	L318 X B67 X H367	0,65	NERO
603020100	LOKHEN	L330 X B65 X H384	0,69	NERO

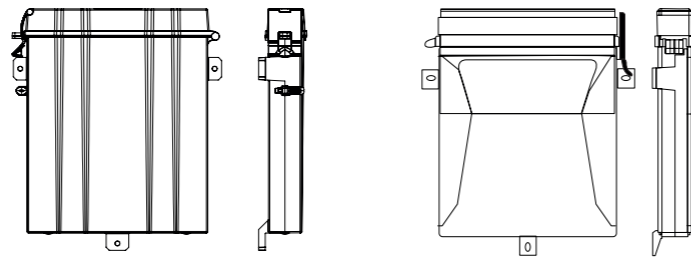

ARTICOLO	MARCA	FORMATO (mm)	PESO kg	COLORE
603000100	LOKHEN	L124 X B115 X H340 - Ø 95	0,36	NERO

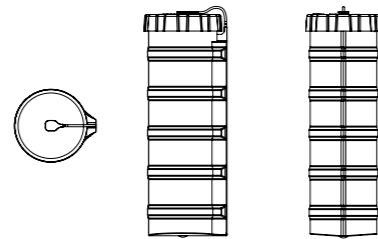

ARTICOLO	MARCA	FORMATO (mm)	PESO kg	COLORE
3805130	POMMIER	L344 X H231	0,55	GRIGIO

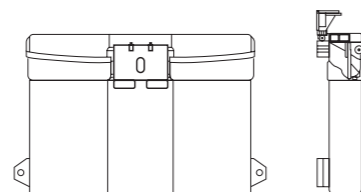

Porta estintore

ESTINTORE DA 6 kg



- Polipropilene
- Nylon
- Policarbonato

ARTICOLO	LINEA	DIM. ESTERNE (mm)	DIAMETRO	PESO kg
8250082500002	STRIKE	A287 X B600 X C220	Ø 150/170	6

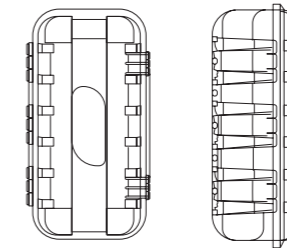

i Materiale plastico con alta resistenza a: fiamme, idrocarburi e oli lubrificanti, raggi UV, alte e basse temperature.

ARTICOLO	LINEA	DIM. ESTERNE (mm)	DIAMETRO	PESO kg
82412	SLIDEN	A265 X B284 X C595	Ø 140/160	2,1

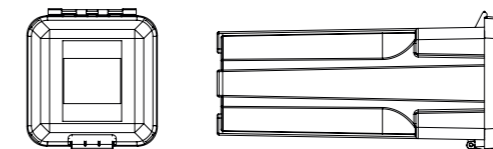

ARTICOLO	LINEA	DIM. ESTERNE (mm)	DIAMETRO	PESO kg
495018010	RELEASEY	A260 X B635 X P275	Ø 150/170	3,85

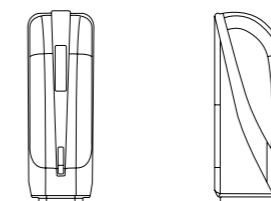

Tenditore telone B 41

PWP



ARTICOLO	PERNO	LATO
17832500501	TONDO	DX
17832500500	TONDO	SX
17832500401	QUADRO	DX
17832500400	QUADRO	SX

i

Acciaio galvanizzato/dacromet

ARTICOLO	KG	SPESSORE	Ø	LATO
3110876	1,25	35	25	DX
3110875	1,25	35	25	SX

Tenditore telone



Tenditore zincato

CON ATTACCO A TAGLIO

Tendi telone per centinature

Profilo in alluminio anodizzato tenditelone Ø 34

i



ARTICOLO	KG	SPESSORE	Ø	LATO
34480012	2,500	40	25	SX
34480013	2,500	40	25	DX

ARTICOLO	KG	SPESSORE	DIMENSIONE	LATO
3110878	1,25	35	12 x 12	SX
3110877	1,25	35	12 x 12	DX

Tenditore telone quadro

A MANOVELLA

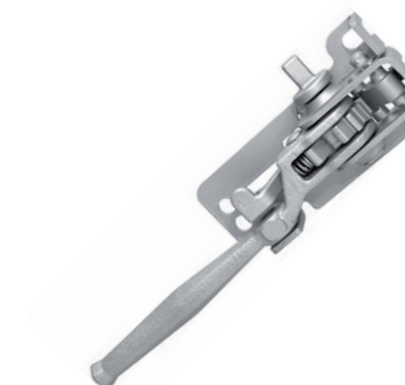

Innesto a squadro

PER PROFILO



ARTICOLO	KG	Ø
34480015	0,215	0.215

Innesto a taglio/inox

PER PROFILO



ARTICOLO	KG	Ø
34480021	0,190	27

Tappo in inox

PER PROFILO



ARTICOLO	KG	Ø
34480019	0,155	26

Connettore per tenditelone

CON ATTACCO 12x12



IN OTTONE



ARTICOLO	Ø
3110864	25
3110866	27



IN ACCIAIO GÉOMET



ARTICOLO	Ø
3110927CS	32,5
3110928CS	27.04

Cavo Tir con copricorda

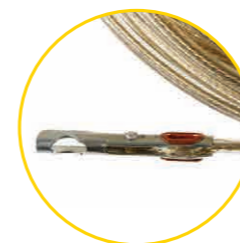

CON APPOSITI CAPICORDA AD INIZIO CAVO

ARTICOLO	MARCA	LUNGHEZZA (mm)
9869.2	TRUCK ITS/RICAMBI	34



- anima in acciaio da 2 mm.
- rivestimento in pvc trasparente ø 5,5 mm



Corda elastica per teloni

COLORE BLU / GRIGIO

ARTICOLO	MARCA	LUNGHEZZA (mm)
110350	TRUCK ITS/RICAMBI	100
120874	TRUCK ITS/RICAMBI	100



ARTICOLI COMPLEMENTARI PER VEICOLI TELONATI

Cricchetto chiusura teloni

ACCIAIO INOX

ARTICOLI COMPLEMENTARI PER VEICOLI TELONATI

ARTICOLO	MARCA
9869.4	TRUCK ITS/RICAMBI



Profili in alluminio per teloni

ALLUMINIO

PROFILO IN ALLUMINIO
PER TELONI

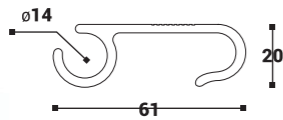
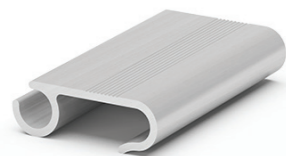

ARTICOLO	MARCA	LUNGHEZZA (metri)
2AB0003/5	TRUCK ITS	5
2AB0003/6	TRUCK ITS	6
2AB0003/6.5	TRUCK ITS	6.5

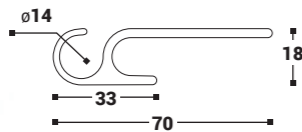
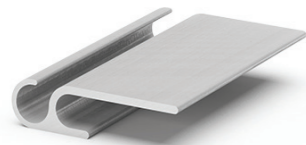

ARTICOLO	MARCA	LUNGHEZZA (metri)
T1 8005	TRUCK ITS	7.5

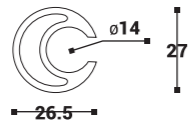
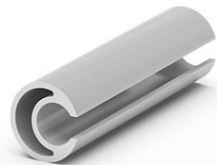

ARTICOLO	MARCA	LUNGHEZZA (metri)
SO1518996	TRUCK ITS	7.5

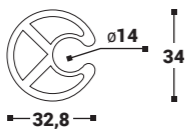

ARTICOLO	MARCA	LUNGHEZZA (metri)
SO1220126	TRUCK ITS	7.5

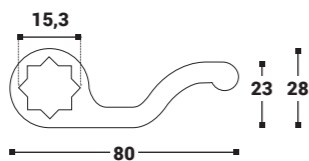
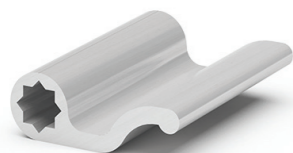

ARTICOLO	MARCA	LUNGHEZZA (metri)
SO221170/7.5	TRUCK ITS	7.5



Tamponi paracolpi

IN GOMMA NERA

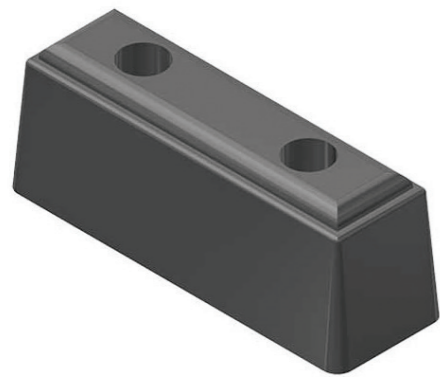

ARTICOLO	MARCA	FORMATO (mm)	PESO kg
55200245	FTS	250 X 85 X 90	1,63

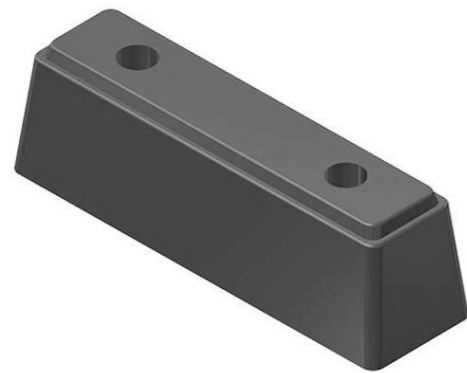
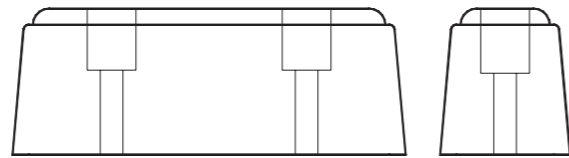

ARTICOLO	MARCA	FORMATO (mm)	PESO kg
55200358	FTS	350 X 100 X 110	3,65

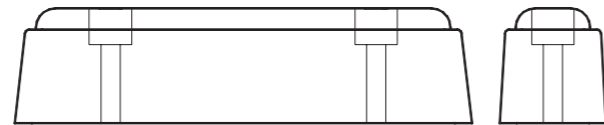

Tamponi paracolpi

IN GOMMA NERA



ACCESSORI SOTTO CASSONE

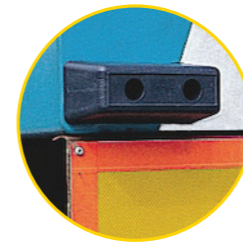

ACCESSORI SOTTO CASSONE

ARTICOLO	MARCA	FORMATO (mm)	PESO kg
55200118	FTS	150 X 60 X 60	0,61

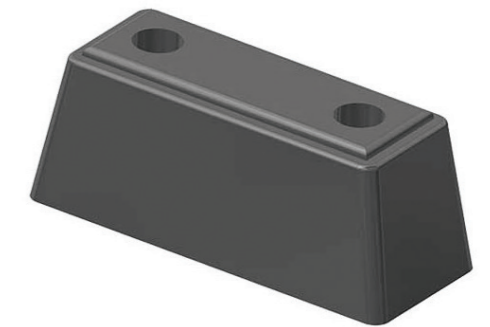
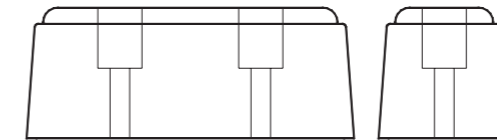

ARTICOLO	MARCA	FORMATO (mm)	PESO kg
55215505	FTS	215 X 50 X 54	0,61

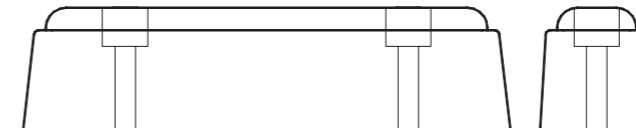

Paracolpi a rullo orizzontale

IN GOMMA NERA



ACCESSORI SOTTO CASSONE



ARTICOLO	MARCA	FORMATO (mm)	PESO kg
3950255GA	POMMIER	165 X 121,5 X 136	4,92

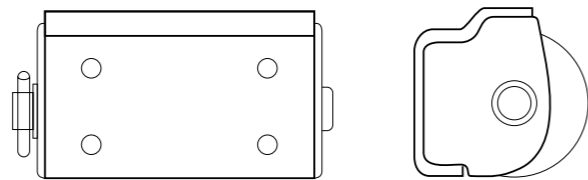

ACCESSORI SOTTO CASSONE



ARTICOLO	MARCA	FORMATO (mm)	PESO kg
55322251	FTS	190 X 110 X 115	5,50

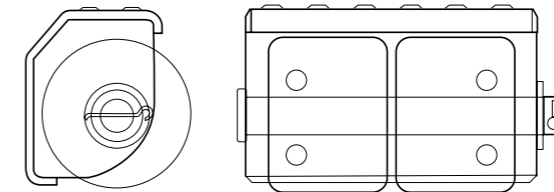

Paracolpi a rullo orizzontale

IN GOMMA NERA

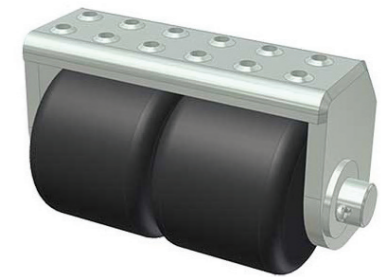

Rullo cilindrico singolo

IN GOMMA NERA



DUE FORMATI DISPONIBILI



ARTICOLO	MARCA	LARGHEZZA	PESO kg
3950250BU	FTS	80	0,975
3950255BU	POMMIER	130	1,505



ARTICOLO	MARCA	FORMATO (mm)	PESO kg
3950250GA	POMMIER	216 X 116 X 144	6

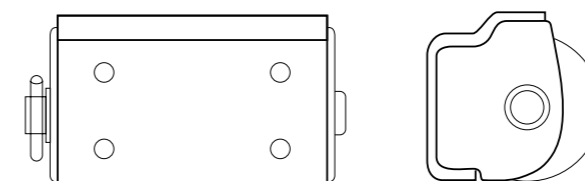

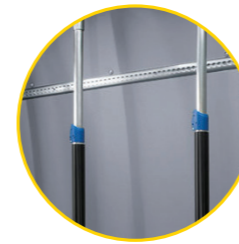

ACCESSORI PER INTERNO

Profilo ferma carico orizzontale

ZINCATO

ARTICOLO	MARCA
50063110	TRUCKS

ARTICOLO	MARCA
TL405018	TRUCKS

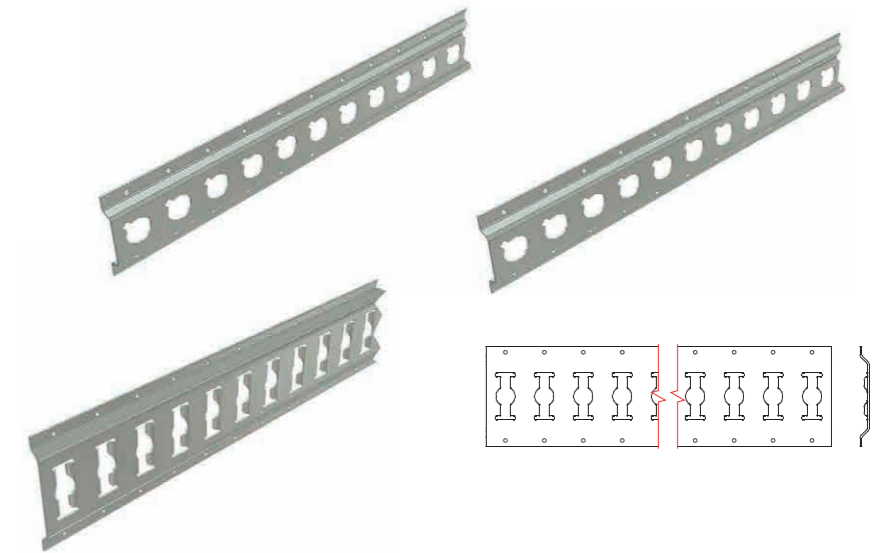

Terminale in ghisa per cremagliera

ARTICOLO TL405018

ARTICOLO	MARCA
510510300	TRUCKS

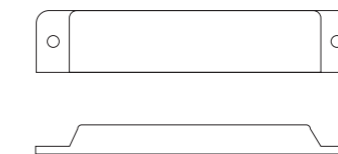

Cinghia con tensore e bloccaggio

1 GANCIO



CRICK TIPO GRANDE
10 METRI



ARTICOLO	MARCA
S/7080	TRUCKS

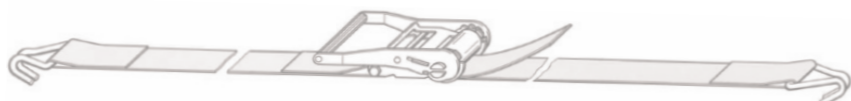
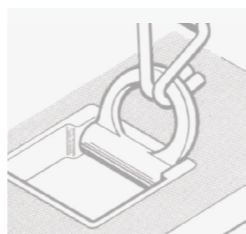

CRICK TIPO MEDIO
PER INTERNO CON AGGANCO CREMAGLIERA

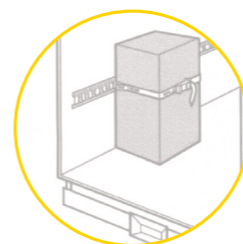

ARTICOLO	MARCA
S/7090	TRUCKS

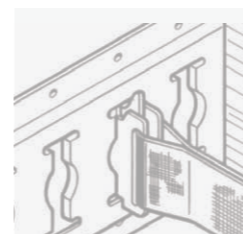

Cinghie fermacarico 3000 kg

5 METRI



CRICK TIPO GRANDE
10 METRI

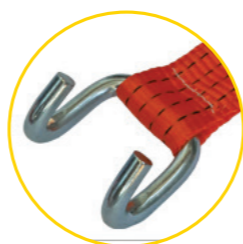

ARTICOLO	MARCA
S/7088	TRUCKS

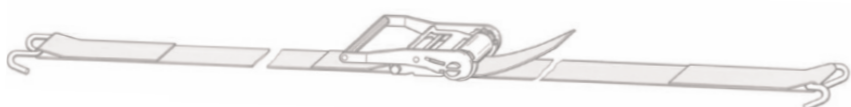

CRICK TIPO GRANDE
PER INTERNO CON AGGANCO CREMAGLIERA

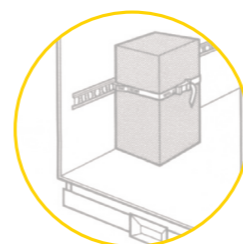

ARTICOLO	MARCA
S/7091	TRUCKS

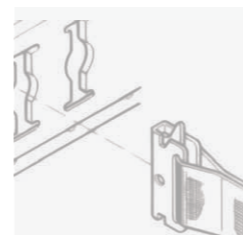

5 METRI



Tampone ricambio asta

RICAMBIO ASTA



COMPATIBILE CON ASTA:
cod. articolo 7010190



ARTICOLO	MARCA	H	D
FC15	TRUCKS	75 mm	80 mm

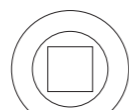

Palo totem fermacarico

ZINCATO

CON FISSAGGIO A PIOLO



ARTICOLO	MARCA	H	D
7010190	TRUCKS	75 mm	80 mm

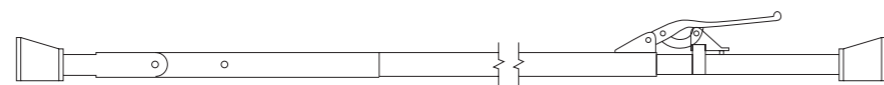

Barra estensibile con pinze

ALLUMINIO ANODIZZATO

i

Estensibile da 2400 a 2700
Protezione in gomma arancione

ARTICOLO	MARCA	L
50030225	TRUCKS	2400 ÷ 2700

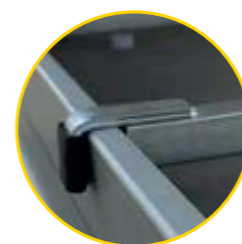
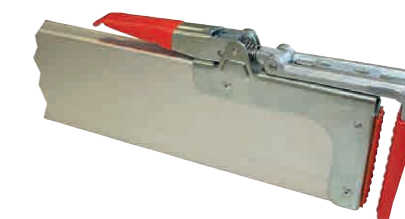
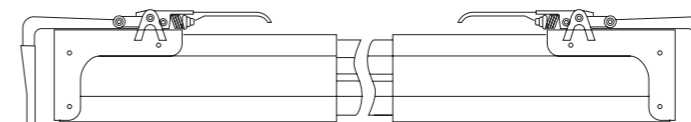

ARTICOLO	MARCA	L
50030250	TRUCKS	1880 ÷ 2880



i

Misura di lavoro: da mm. 1940 a mm. 2600;
Sezione tubo esterno: mm. 40 x 40 x 1,5;
Sezione tubo interno: mm. 35 x 35 x 1,5

ARTICOLO	MARCA	L
511110313	TRUCKS	236 ÷ 2760



Asta ferma carico

ALLUMINIO ANODIZZATO



Scaletta estraibile zincata a freddo

GRADINO AMPIO

ARTICOLO	GRADINI	FORMATO (mm)	KG
5042270	4	L1 1269 L2 1592 - P 497 - B 706 - H 841 - S 60	24,5
TK 9120	5	L1 1471 L2 1877 - P 497 - B 706 - H 1042 - S 60	26

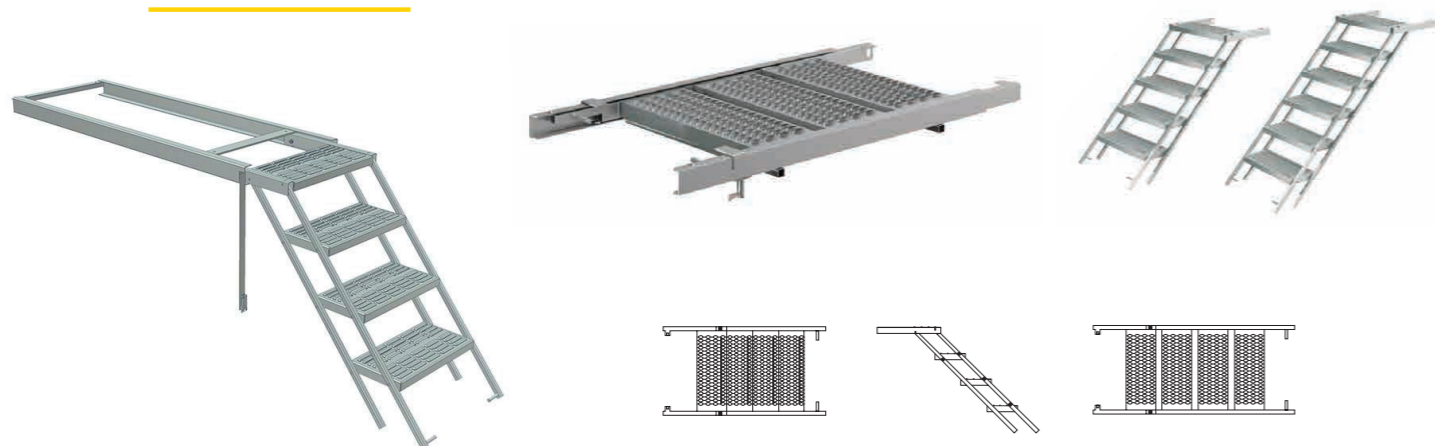

Scaletta estraibile zincata a freddo

SENZA PEDANA

ARTICOLO	GRADINI	FORMATO (mm)	KG
90595	1	L1 600 - L2 400 - B 420 - H 310 - S 69	4,3
TK 8615	2	L1 850 - L2 570 - B 420 - H 460 - S 69	6,09
TK 8625	3	L1 120 - L2 750 - B 420 - H 600 - S 69	7,82

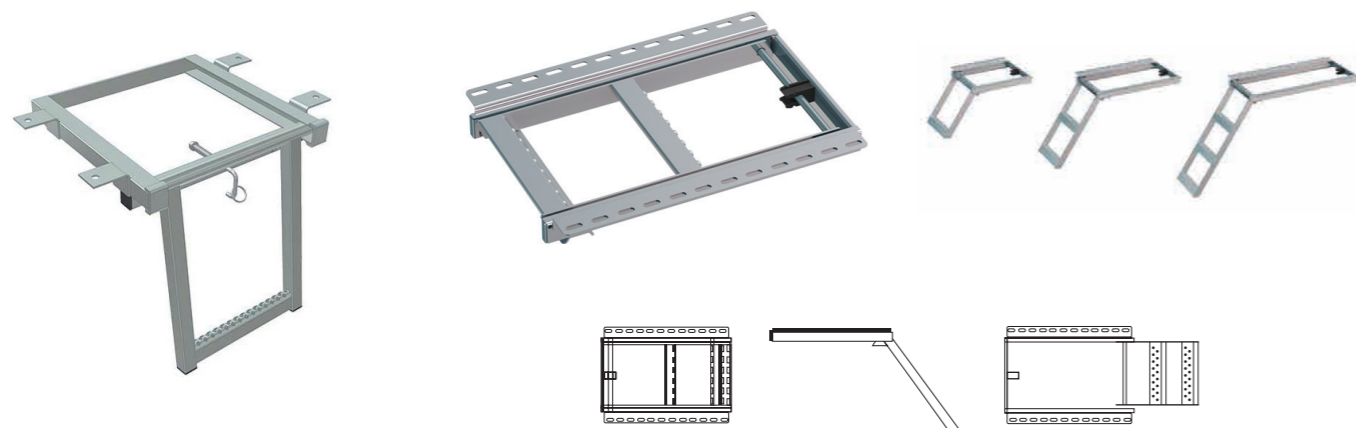

Basi

ARTICOLO	DIMENSIONE	DIAMETRO
FER40X400X400	40 x 400 x 400	300
FER50X400X400	50 x 400 x 400	300
CIF50X500X500FB	50 x 500 x 500	300
CIF50X600X600FB/350	50 x 600 x 600	350
FER80X1200X1200	80 x 1200 x 1200	-



Porta basi

ZINCATO

Disponibile in due misure.

ARTICOLO	DIMENSIONE	SP
PORTABASI400/50	400 x 400	120
PORTABASI500/50	500 x 500	120



Fanale laterale LED 12/24V

CON STAFFA

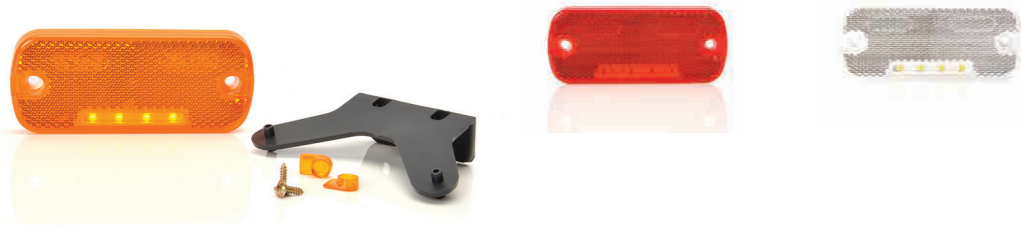

ARTICOLO	COLORE
33.904	ARANCIO
33.905	ROSSO
33.906	BIANCO



La resistenza ai fattori esterni è stata aumentata attraverso un aumento dell'ermetizzazione circuito elettronico e coperchio supplementare con un diffusore.

Fanale laterale LED "slim" 12/24V

CON STAFFA



ARTICOLO	COLORE
33.1338	ARANCIO
33.1339	ROSSO
33.1340	BIANCO



La resistenza ai fattori esterni è stata aumentata attraverso un aumento dell'ermetizzazione circuito elettronico e coperchio supplementare con un diffusore.

Fanale a 3 LED piatto 12/24V



ARTICOLO	COLORE
39.940.000	ARANCIO
39.942.000	BIANCO
39.944.000	ROSSO

COMPATIBILITÀ: SERIE 39.94*, ***

ARTICOLO
39.940.307



Staffa montaggio fanale

SOTTOCASSONE

Fanale piatto 4 LED 12/24V



ARTICOLO	COLORE
39.940.100	ARANCIO
39.942.100	BIANCO
39.944.100	ROSSO

ARTICOLO	COLORE
33.1402	ARANCIO
33.1403	ROSSO
33.1404	BIANCO



Fanale ingombro LED 12/24V

CON STAFFA

Fanale laterale multiLED 12/24V

CON STAFFA



ARTICOLO	COLORE
33.534Z	ARANCIO
33.535	ROSSO
33.536	BIANCO

Fanale ingombro a LED 12/24V

CON STAFFA



ARTICOLO	COLORE
33.1399	ARANCIO
33.1400	ROSSO
33.1401	BIANCO

Fanale laterale a 2 LED 12/24V

CON STAFFA



ARTICOLO	COLORE
33.070Z	ARANCIO
33.070C	ROSSO
33.070B	BIANCO

Fanale ingombro a LED 12/24V

CON STAFFA



ARTICOLO	COLORE
33.1386	ARANCIO

Fanale laterale a 2 LED 12/24V

CON STAFFA



ARTICOLO	COLORE
33.072C	ROSSO
33.072B	BIANCO
33.072Z	ARANCIO

Fanale ingombro laterale a 2 LED 12/24V



ARTICOLO	COLORE
33.101Z	ARANCIO

Fanale ingombro 12/24V

CON STAFFA



ARTICOLO	COLORE
33.1138	ARANCIO
33.1139	ROSSO
33.1140	BIANCO

Fanale LED lungo piatto 12/24V

CON CAVO



ARTICOLO	COLORE
33.195B	BIANCO
33.195C	ROSSO
33.195Z	ARANCIO

Fanale ingombro laterale a 2 LED 12/24V



ARTICOLO	COLORE
33.308Z	ARANCIO
33.310P	ROSSO
33.309P	BIANCO

ARTICOLO	COLORE
33.713	BIANCO
33.713G	VERDE



Fanale a 6 LED "slim" 12/24V

CON CAVO



La resistenza ai fattori esterni è stata aumentata attraverso un aumento dell'ermetizzazione circuito elettronico e coperchio supplementare con un diffusore.



Fanale ingombro a LED 12/24V

CON STAFFA



ARTICOLO	COLORE
33.1598	ARANCIO
33.1599	ROSSO
33.1600	BIANCO

ARTICOLO	COLORE
33.711	ARANCIO
33.712	ROSSO



Fanale a 5 LED "slim" 12/24V

CON CAVO



Luce di posizione posteriore LED 12/24V

CON CAVO

ARTICOLO	COLORE
33.768	ARANCIO
33.769	BIANCO
33.770	ROSSO



Fanale lungo multiLED "slim" 12/36V

CON CAVO

ARTICOLO	COLORE
33.092C	ROSSO
33.092Z	ARANCIO
33.092B	BIANCO



La resistenza ai fattori esterni è stata aumentata attraverso un aumento dell'ermetizzazione circuito elettronico e coperchio supplementare con un diffusore.



Fanale multiLED lungo "slim" 12/24V

CON CAVO

ARTICOLO	COLORE
33.717	ARANCIO
33.721	ROSSO
33.729	BIANCO
33.719GREEN	VERDE



ARTICOLO	COLORE
33.45A	ARANCIO
33.45B	BIANCO
33.45C	ROSSO
33.45Z	VERDE



Fanale a LED tipo laser 12/24V

CON CAVO

Fanale lungo multiLED "slim" 12/36V

CON STAFFA

ARTICOLO	COLORE
33.073BLEDLONG	BIANCO
33.073ZLEDLONG	ARANCIO
33.073CLEDLONG	ROSSO
33.073ZIELLEDLONG	VERDE



ARTICOLO	COLORE
33.714	ARANCIO
33.715	ROSSO
33.716	BIANCO



Fanale ingombro multiLED "slim"

CON CAVO

Luce di posizione laterale a LED/NEON 12/24V

CON CAVO



ARTICOLO	COLORE
33.765	ARANCIO
33.766	BIANCO
33.767	ROSSO

Fanale LED ad incasso a 2 LED 12/24V

ARTICOLO	COLORE
12387	ARANCIO
12388	BIANCO
12389	ROSSO
12391	VERDE



Fanale a 3 LED piatto 12/24V



ARTICOLO	COLORE
33.074N	BLU
33.074Z	GIALLO
33.074C	ROSSO
33.074B	BIANCO
33.074ZIEL	VERDE

ARTICOLO	COLORE
33.073CDARK	ROSSO
33.073ZDARK	ARANCIO
33.073BDARK	BIANCO



Fanalino ingombro a 4 LED 12/24V - Fumé



Fanale ingombro a 4 LED 12/24V

CON CAVO



ARTICOLO	COLORE
33.073CLED	ROSSO
33.073ZLED	ARANCIO
33.073BLED	BIANCO
33.073ZIELLED	VERDE

ARTICOLO	COLORE
33.1341	ARANCIO
33.1342	ROSSO
33.1343	BIANCO



Luce di posizione LED 12/24V

CON CAVO

Fanale ingombro 12/24V

- Indicatore di posizione combinato, luce anteriore-posteriore e indicatore posteriore
- Basso consumo energetico

ARTICOLO	TIPOLOGIA
39.2085L	CORTO C/FRECCIA
39.2085P	CORTO C/FRECCIA
39.2067L	LUNGO NO FRECCIA
39.2067P	LUNGO NO FRECCIA



Fanale ingombro 12/24V

- Indicatore di posizione combinato, luce anteriore-posteriore e indicatore posteriore
- Basso consumo energetico
- **Con freccia**

ARTICOLO	TIPOLOGIA
39.1167P	corto DX
39.1167L	corto SX
39.1259L	c/freccia SX
39.1259P	c/freccia DX



Fanale ingombro LED laterale 12/24V

ARTICOLO	VERSIONE
39.792L	SX
39.792P	DX



Fanale dritto/corto ingombro LED 12/24V

- Basso consumo energetico
- **3 COLORI:** arancio, bianco, rosso



Fanale ingombro LED 12/24V

- TIPO ASPOCK
- **3 COLORI:** arancio, bianco, rosso

ARTICOLO	VERSIONE
39.238L	SX
39.238P	DX



Fanale dritto ingombro LED 12/24V

- Basso consumo energetico
- **3 COLORI:** arancio, bianco, rosso



Fanale curvo ingombro LED 12/24V



ARTICOLO	VERSIONE
39.297L	SX
39.297P	DX

Fanale dritto ingombro LED 12/24V



ARTICOLO	VERSIONE
39.295L	SX
39.295P	DX

Fanale corto ingombro LED 12/24V



ARTICOLO	COLORE
39.293	BIANCO/ROSSO

Fanale dritto ingombro LED 12/24V



ARTICOLO	COLORE
33.518	BIANCO/ROSSO

Fanale curvo ingombro LED 12/24V



ARTICOLO	COLORE
33.883	BIANCO/ROSSO

Luce di posizione LED 12/24V



ARTICOLO	COLORE
781	ARANCIO/BIANCO

Ricambio per fanale ingombro LED 12/24V



ARTICOLO	COLORE
33.301	BIANCO/ROSSO

ARTICOLO	COLORE
33.881	BIANCO/ROSSO

COLORE

Fanale posteriore LED 12/24V



ARTICOLO	LATO
44.170LNT	SX
44.170PNT	DX

Fanale posteriore LED/NEON 12/24V



ARTICOLO	LATO
44.1014	SX
44.1012	DX

Fanale posteriore LED dx/sx rimorchio 12/24V

- 6 FUNZIONI**
- Posizione
 - Freccia dinamica
 - Retromarcia
 - Stop

- Fendinebbia
- Con luce targa
- Con cavo da 1 mt



ARTICOLO	LATO
44.610LTLED	SX
44.610PTLED	DX

Fanale posteriore LED per motrice 12/24V

ARTICOLO	LATO
44.600LTLED	SX
44.600PTLED	DX

7 FUNZIONI

- Posizione
- Freccia dinamica
- Retromarcia
- Stop
- Catarifrangenti
- Fendinebbia
- Con luce targa
- Con cavo da 1 mt



DESTRA/SINISTRA

Fanale posteriore LED 12/24V

ARTICOLO	LATO
44.1105L	SX
44.1108P	DX

7 FUNZIONI

- Posizione
- Freccie
- Retromarcia
- Stop
- Catarifrangenti
- Fendinebbia
- Senza luce targa
- Con cavo da 1 mt



DESTRA/SINISTRA

Fanale posteriore LED 12/24V

ARTICOLO	LATO
44.847.LED	DX
44.849.LED	SX

- 7 luci
- Multifunzione
- Per motrice



DESTRA/SINISTRA

Fanale 5 funzioni LED 12/24V

DESTRA/SINISTRA

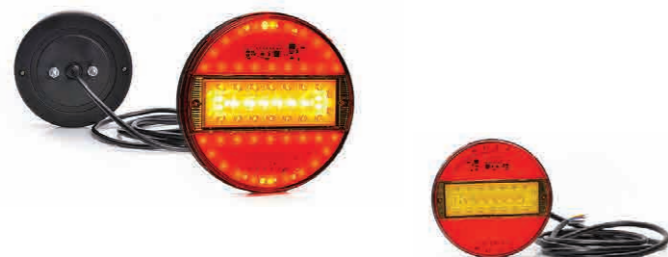

ARTICOLO

44.742

Fanale posteriore tondo a "nido d'ape" LED 12/24V

DESTRA/SINISTRA



3 FUNZIONI

- Luci di posizione
- Stop
- freccia

ARTICOLO

44.980

Fanale posteriore tondo a "nido d'ape" LED 12/24V

DESTRA/SINISTRA



2 FUNZIONI

- Retronebbia
- Retromarcia

ARTICOLO

44.1092/I

Fanale 6 funzioni LED 12/24V

DESTRA/SINISTRA



ARTICOLO

44.130

Fanale posteriore LED 12/24V "Scania dal 2010"

- Con avvisatore acustico retromarcia
- Luce targa

ARTICOLO	LATO
7620504	DX
7620505	SX



Fanale posteriore LED 12/24V "Volvo dal 2013"

- Con avvisatore acustico retromarcia

ARTICOLO	LATO
8724500	DX
8724501	SX



Fanale posteriore tondo LED 12/24V



- Stop
- Luci di posizione
- Freccia dinamica

ARTICOLO
44.1129

DESTRA/SINISTRA

Fanale posteriore tondo LED 12/24V



- Luci di posizione
- Retronebbia
- Retromarcia

ARTICOLO
44.113012F

DESTRA/SINISTRA

Fanale posteriore quadrato LED 12/24V



- Luci di posizione
- Retronebbia
- Retromarcia



ARTICOLO
44.1091

DESTRA/SINISTRA

Fanale posteriore quadrato LED 24V



- Stop
- Luci di posizione
- Freccia



ARTICOLO
44.1089

DESTRA/SINISTRA

Fanale posteriore motrice LED 12/24V

- Con cavo per motrice



ARTICOLO	LATO
44.1200	DX
44.1197	SX

Fanale posteriore rimorchio LED 12/24V

- Con cavo per rimorchio



ARTICOLO	LATO
44.1188	DX
44.1185	SX

Fanale posteriore rimorchio LED 12/24V

- Led con connettore



ARTICOLO	LATO
MDFR1450	DX
MDFR1449	SX

Fanale posteriore LED 12/24V "slim"

- Con Indicatore freccia dinamico
- Cavo



ARTICOLO	LATO
L1949	SX
L1950	DX

Fanale posteriore ultra sottile rimorchio LED 12/24V

- Con Indicatore freccia dinamico
- Cavo



ARTICOLO	LATO
L1918	SX
L1919	DX

Fanale posteriore ultra sottile motrice LED/NEON 12/24V

- Con Indicatore freccia dinamico
- Cavo



ARTICOLO
L1916

DESTRA/SINISTRA

Fanale posteriore motrice ultra sottile LED 12/24V

- Con cavo per rimorchio



ARTICOLO	LATO
04949000	DX
04950000	SX

Fanale posteriore motrice ultra sottile LED 12/24V

- Con cavo per rimorchio



ARTICOLO	LATO
L1859	SX
L1860	DX

Fanale posteriore rimorchio LED 12/24V

CON TRIANGOLO



ARTICOLO	LATO
44.700066L	SX
44.700066P	DX

Fanale posteriore ultra sottile LED 12/24V

DESTRA/SINISTRA

- Multifunzione IP68
- Con luce di posizione posteriore
- Con luce freno indicatore posteriore motrice



ARTICOLO
L4561

ARTICOLO
85.1027

Luce d'emergenza LED 12/24V

ARANCIO



ARTICOLO
85.1028

Luce d'emergenza LED 12/24V

BLU



Fanale posteriore ultra sottile LED 12/24V

DESTRA/SINISTRA

- Multifunzione IP68
- Con luce di posizione posteriore
- Con luce stop



ARTICOLO
L4559

ARTICOLO
S/7032

Lampeggiante LED/flash magnetico 12/24V



Fanale posteriore LED 12/24V

CON CAVO

- Multifunzione: posizione, freccia e stop



ARTICOLO
44.410

ARTICOLO
S/7034

Lampeggiante flessibile LED/flash 12/24V



Fanale LED lampeggiante 12/24V

ARANCIO



ARTICOLO
11.1468ECO

Lampeggiante LED 12/24V

BLU



ARTICOLO
867.4

Fanale LED lampeggiante 12/24V

BLU



ARTICOLO
33.1470ECO

Lampeggiante flash 12/24V

ANTERIORE



ARTICOLO	COLORE	LUCE
85.898.2	TRASPARENTE	ARANCIO
85.898.1	ARANCIO	ARANCIO

Fanale lungo 6 LED 12/24V



ARTICOLO	COLORE
33.200LED	ARANCIO

Lampeggiante flash blu 12/24V

ANTERIORE



ARTICOLO	COLORE
85.899.1	BLU

Fanale lungo 3 LED 12/24V



ARTICOLO	COLORE
33.210LED	ARANCIO

Lampeggiante pico LED magnetico 12/24V



ARTICOLO	COLORE
ALR0056	BLU

R10/R65

Lampeggiante pico LED magnetico 12/24V



ARTICOLO	COLORE
ALR0054	ARANCIO

R10/R65

Lampeggiante strobo 10W 4 LED 12/24V



ARTICOLO	COLORE
LW0043	ARANCIO

R10/R65 XA2

Segnalatore luminoso LED 12/24V



628X35 R65/R10

ARTICOLO	COLORE
BLK0036	ARANCIO

Segnalatore luminoso LED 12/24V



916x35 R65/R10

ARTICOLO	COLORE
BLK0037	ARANCIO

Lampeggiante tipo america LED 12/24V



1172mm R65/R10

ARTICOLO	COLORE
BLK0008	ARANCIO

Lampeggiante tipo america LED/flash 12/24V



1492mm R65/R10

ARTICOLO	COLORE
BLK0009	ARANCIO

Avvertimento LED 12/24V

614mm R10 R65



ARTICOLO	COLORE
BLK0039	ARANCIO

Lampeggiante tipo america LED/flash 12/24V

595x305x56mm R65/R10



ARTICOLO	COLORE
BLK0002	ARANCIO

Avvertimento LED 12/24V

1223mm R10 R65



ARTICOLO	COLORE
BLK0042	ARANCIO

Lampeggiante arancio LED super slim 12/24V

473x23mm R10/R65



ARTICOLO	COLORE
BLK0044	ARANCIO

Avvertimento LED 12/24V

1528mm R10 R65



ARTICOLO	COLORE
BLK0043	ARANCIO

Avvertimento LED 12/24V

776mm R10 R65



ARTICOLO	COLORE
BLK0040	ARANCIO

Fanale targa bombato LED 12/24V

ROSSO



ARTICOLO

55.409

- + LUCE DI POSIZIONE
- + STROBO AMBRA

ARTICOLO COLORE

L3436 ARANCIO

Luce di profondità LED X-SPIDER

CON CAVO



Fanale targa piccolo LED 12/24V

ROSSO



ARTICOLO

55.245

- + LUCE DI POSIZIONE
- + STROBO AMBRA

ARTICOLO COLORE

L3440 ARANCIO

Luce di profondità LED X-TOXIC

CON CAVO



Luce di profondità LED X-SPIDER NINJA

CON CAVO



- + LUCE DI POSIZIONE
- + STROBO AMBRA
- + OVALE

ARTICOLO COLORE

L3443 ARANCIO

Lampada frontale BEZEL-LESS media 12/24V LED



ARTICOLO
L3425

ARTICOLO
1FE008773081

- Montaggio, esterno
- Lente diffusore cristallina



Faro di profondità Jumbo 320 12/24V

DESTRA/SINISTRA

Faro LED + posizione striscia LED 12/24V



ARTICOLO
L3421

Faro LED + posizione striscia LED 12/24V



ARTICOLO
L3424

Faro LED BEZEL-LESS+ LED 12/24V+ posizione strip



ARTICOLO
L3423

Lampada da lavoro 12 LED 12/24V

CUBO



ARTICOLO	COLORE
L0064	ARANCIO

Faro da lavoro LED 12/24V

CAVO 1,5



ARTICOLO	COLORE
71.063	BIANCO

ATTACCO A SNODO

Faretto work lamp 5 LED 12/24V

QUADRATO



ARTICOLO	COLORE
L2204	BIANCA

Faro frontale 2xLED 12/24V



ARTICOLO
L3420

Faretto work lamp 6 LED 12/24V

TONDO



ARTICOLO	COLORE
L2205	BIANCA

Lampada frontale BEZEL-LESS + posizione 12/24V



ARTICOLO
L3422

Faro da lavoro multi LED 12/24V



ARTICOLO	COLORE
71.685	BIANCA

Lampada da lavoro 6xLED 12/24V



ARTICOLO
L0180

Faro da lavoro LED 12/24V



ARTICOLO
11.161

ARTICOLO	COLORE
7170	ROSSO
7169	BIANCO
7166	GIALLO

Nastro rifrangente 3M segmentato per teloni

BOBINA DA 50 MT



Lampada interna lunga 12/24V



ARTICOLO
L1881

ARTICOLO	COLORE
7167	ROSSO
7168	BIANCO
7165	GIALLO

Nastro rifrangente 3M per superfici rigide

BOBINA DA 50 MT



ARTICOLO	COLORE
70703	ROSSO
70702	BIANCO
70701	GIALLO

Nastro rifrangente Orafol per superfici rigide

BOBINA DA 50 MT



ARTICOLO	COLORE
70761	GIALLO
70762	BIANCO
70763	ROSSO

Nastro rifrangente Orafol segmentato per teloni

BOBINA DA 50 MT



pannelli e limite velocità

ARTICOLO	MATERIALE
S/7050	ALLUMINIO
S/7050.A	ADESIVO

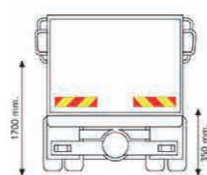

Coppia pannelli per motrice



ARTICOLO	MATERIALE
S/7052	ALLUMINIO
S/7052.A	ADESIVO

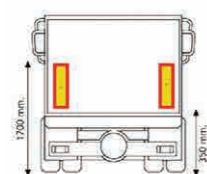

Coppia pannelli per rimorchio



Disco limite velocità omologato

ARTICOLO	MATERIALE
S/7005	ADESIVO

100 KM/H



ARTICOLO	MATERIALE
S/7004	ADESIVO

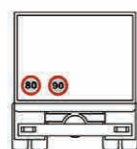

80 KM/H



ARTICOLO	MATERIALE
S/7001	ADESIVO

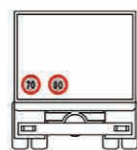

70 KM/H



ARTICOLO	MATERIALE
S/7000	ADESIVO

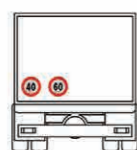

60 KM/H



ARTICOLO	MATERIALE
S/7002	ADESIVO

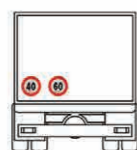

40 KM/H





ITS ITALIA

